



CERAMIC

# High Pass Filter

## HFCN-103+

50Ω 9700 to 15000 MHz

### THE BIG DEAL

- Small size (0.12 x 0.06 x .04")
- 7 sections
- Temperature stable
- Excellent power handling, 7W
- Hermetically sealed
- Low cost

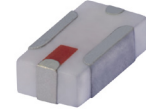

Generic photo used for illustration purposes only

CASE STYLE: FV1206-4

#### +RoHS Compliant

The +Suffix identifies RoHS Compliance. See our web site for RoHS Compliance methodologies and qualifications

### APPLICATIONS

- Sub-harmonic rejection
- Transmitters/receivers
- Lab use

### PRODUCT OVERVIEW

The HFCN-103+ is an LTCC based 7 section design, that extends the upper frequency cut-off range of the existing HFCN series to 10 GHz. Systems that previously relied on large distributed filter elements to support these lower frequencies can save space and system complexity by integrating the HFCN-103+ into new designs. These filters are offered in a EIA 1206 package size and have a typical stop band rejection of 30 dB.

### KEY FEATURES

Feature	Advantages
Small Size (3.2mm x 1.6 mm)	Available in the size of typical resistors or capacitors (EIA 1706), the ultra small HFCN series integrates up to 7 high pass sections in a simple SMT chip form factor.
High Power Handling	The HFCN series can withstand up to 7W CW signal without damage making this filter ideal for use in medium power to transmit paths.
Temperature Stability	Over a 155°C operating temperature range (-55°C to +100°C), the HFCN series ceramic filters typically exhibit low pass band insertion loss variation.
High Rejection	Achieving 30dB rejection from DC-5700 MHz; the HFCN-103+ provides a versatile high pass configuration for many up converter applications.

REV. F  
ECO-012120  
HFCN-103+  
AD/CP/AM  
220209





CERAMIC

# High Pass Filter

## HFCN-103+

### ELECTRICAL SPECIFICATIONS<sup>1,2</sup> AT 25°C

Parameter	F#	Frequency (MHz)	Min.	Typ.	Max.	Units	
Stop Band	Rejection Loss	DC-F1	DC-5700	30	—	—	dB
		F1-F2	DC-6500	20	—	—	
	Freq. Cut-Off	F3	8400	—	3.0	—	dB
	VSWR	DC-F2	DC-6500	—	20	—	:1
Pass Band	Insertion Loss	F4-F7	9700 - 15000	—	—	2.0	dB
		F5-F6	10000 - 11000	—	—	1.8	dB
	VSWR	F4-F7	9700 - 15000	—	2.0	—	:1

1. In Application where DC voltage is present at either input or output ports, dc de-coupling capacitors are required.

2. Measured on Mini-Circuits Characterization Test Board TB-637+.

### MAXIMUM RATINGS

Parameter	Ratings
Operating temperature	-55°C to +100°C
Storage temperature	-55°C to +100°C
RF Power Input <sup>3</sup>	7W max. at 25°C

3. Passband rating, derate linearly to 3W at 100°C ambient. Permanent damage may occur if any of these limits are exceeded.

### TYPICAL FREQUENCY RESPONSE

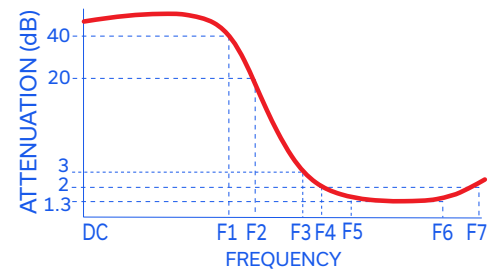

### FUNCTIONAL SCHEMATIC

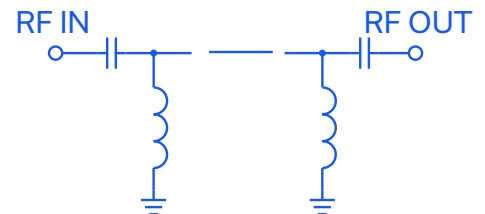



CERAMIC

# High Pass Filter

# HFCN-103+

### PIN CONNECTIONS

RF IN	1
RF OUT	3
GROUND	2,4

PRODUCT MARKING: AR

DEMO BOARD MCL P/N: TB-637+  
SUGGESTED PCB LAYOUT (PL-530)

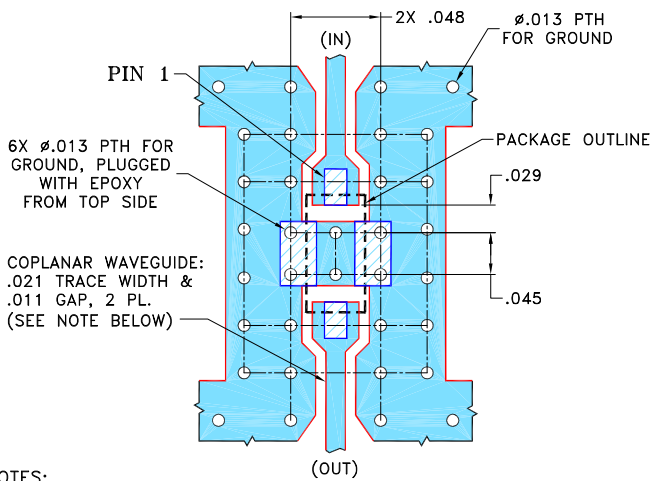

**NOTES:**

- TRACE WIDTH & GAP ARE SHOWN FOR ROGERS R04350B WITH DIELECTRIC THICKNESS  $.010 \pm .001$ ; COPPER: 1/2 OZ. EACH SIDE. FOR OTHER MATERIALS TRACE WIDTH MAY NEED TO BE MODIFIED.
- BOTTOM SIDE OF THE PCB IS CONTINUOUS GROUND PLANE.

- DENOTES PCB COPPER LAYOUT WITH SMOBC (SOLDER MASK OVER BARE COPPER)
- DENOTES COPPER LAND PATTERN FREE OF SOLDER MASK

### OUTLINE DRAWING

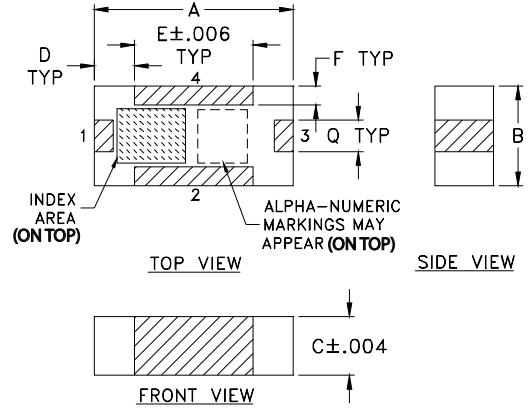

### PCB Land Pattern

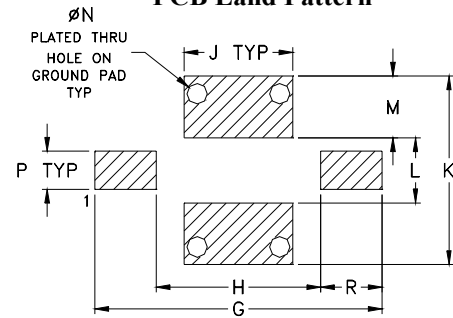

Suggested Layout,  
Tolerance to be within  $\pm .002$

### OUTLINE DIMENSIONS (Inches mm)

A	B	C	D	E	F	G	H	J
.126	.063	.037	.026	.075	.012	.182	.104	.069
3.20	1.60	0.94	0.66	1.91	0.30	4.62	2.64	1.75
K	L	M	N	P	Q	R	wt	
.119	.041	.039	.013	.024	.020	.039	grams	
3.02	1.04	0.99	0.33	0.61	0.51	0.99	.020	

TAPE & REEL INFORMATION: F75



CERAMIC

# High Pass Filter

## HFCN-103+

Mini-Circuits

### TYPICAL PERFORMANCE DATA AT 25°C

Frequency (MHz)	Insertion Loss (dB)	VSWR :1
10.00	71.76	322.99
100.00	52.00	394.14
1000.00	34.16	174.73
2160.00	33.48	106.97
4080.00	39.88	89.02
5030.00	44.64	64.14
10050.00	1.22	1.60
12170.00	1.14	1.70
14070.00	1.01	1.15
15200.00	1.18	1.65

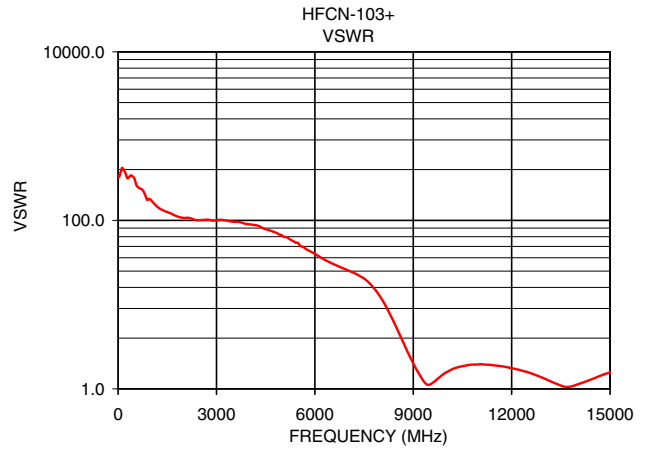
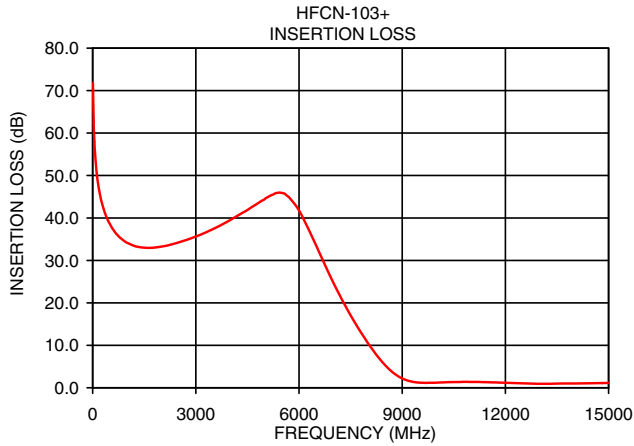

#### NOTES

- A. Performance and quality attributes and conditions not expressly stated in this specification document are intended to be excluded and do not form a part of this specification document.
- B. Electrical specifications and performance data contained in this specification document are based on Mini-Circuit's applicable established test performance criteria and measurement instructions.
- C. The parts covered by this specification document are subject to Mini-Circuits standard limited warranty and terms and conditions (collectively, "Standard Terms"); Purchasers of this part are entitled to the rights and benefits contained therein. For a full statement of the standard. Terms and the exclusive rights and remedies thereunder, please visit Mini-Circuits' website at [www.minicircuits.com/MCLStore/terms.jsp](http://www.minicircuits.com/MCLStore/terms.jsp)

