

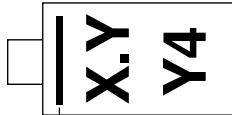

Small Signal Zener Diodes



MARKING (example only)



X.Y = type code
Y4 = date code

23210 Cathode mark

LINKS TO ADDITIONAL RESOURCES



FEATURES

- Silicon planar Zener diodes
- Standard Zener voltage tolerance is $\pm 5\%$ with a "B" suffix (e.g.: MMSZ5225B), suffix "C" is $\pm 2\%$ tolerance
- AEC-Q101 qualified available
- ESD capability according to AEC-Q101: Human body model $> 8\text{ kV}$ Machine model $> 800\text{ V}$
- Base P/N-E3 - RoHS-compliant, commercial grade
- Base P/N-HE3_A - RoHS-compliant, AEC-Q101 qualified
- Material categorization: for definitions of compliance please see www.vishay.com/doc?99912



RoHS COMPLIANT

PRIMARY CHARACTERISTICS		
PARAMETER	VALUE	UNIT
V_Z range nom.	3.0 to 75	V
Test current I_{ZT}	1.7 to 20	mA
V_Z specification	Thermal equilibrium	
Circuit configuration	Single	

ORDERING INFORMATION					
DEVICE NAME	ORDERING CODE	ZENER VOLTAGE TOLERANCE	AEC-Q101 QUALIFIED	TAPED UNITS PER REEL	MINIMUM ORDER QUANTITY
MMSZ5225 to MMSZ5267	MMSZ5225B-E3-08 to MMSZ5267B-E3-08	5 %	no	3000 (8 mm tape on 7" reel)	15 000/box
	MMSZ5225C-E3-08 to MMSZ5267C-E3-08	2 %	no		
	MMSZ5225B-HE3_A-08 to MMSZ5267B-H3_A-08	5 %	yes		
	MMSZ5225C-HE3_A-08 to MMSZ5267C-H3_A-08	2 %	yes		
	MMSZ5225B-E3-18 to MMSZ5267B-E3-18	5 %	no	10 000 (8 mm tape on 13" reel)	10 000/box
	MMSZ5225C-E3-18 to MMSZ5267C-E3-18	2 %	no		
	MMSZ5225B-HE3_A-18 to MMSZ5267B-H3_A-18	5 %	yes		
	MMSZ5225C-HE3_A-18 to MMSZ5267C-H3_A-18	2 %	yes		

PACKAGE				
PACKAGE NAME	WEIGHT	MOLDING COMPOUND FLAMMABILITY RATING	MOISTURE SENSITIVITY LEVEL	SOLDERING CONDITIONS
SOD-123	10.6 mg	UL 94 V-0	MSL level 1 (according J-STD-020)	Peak temperature max. 260 °C

ABSOLUTE MAXIMUM RATINGS ($T_{amb} = 25\text{ °C}$, unless otherwise specified)				
PARAMETER	TEST CONDITION	SYMBOL	VALUE	UNIT
Power dissipation	$R_{thJL} = 250\text{ K/W}$	P_{tot}	500	mW
	On FR-4 board with recommended soldering footprint	P_{tot}	300	mW
Thermal resistance junction to lead		R_{thJL}	250	K/W
Thermal resistance junction to ambient	According to JEDEC® 51-3 on FR-4 board with recommended soldering footprint	R_{thJA}	420	K/W
Junction temperature		T_j	150	°C
Storage temperature range		T_{stg}	-65 to +150	
Operating temperature range		T_{op}	-55 to +150	



ELECTRICAL CHARACTERISTICS (T _{amb} = 25 °C, unless otherwise specified)										
PART NUMBER	MARKING CODE		ZENER VOLTAGE RANGE ⁽¹⁾	TEST CURRENT		REVERSE LEAKAGE CURRENT		DYNAMIC RESISTANCE		TEMPERATURE COEFFICIENT
			V _Z at I _{ZT1}	I _{ZT1}	I _{ZT2}	I _R at V _R		Z _Z at I _{ZT1}	Z _{ZK} at I _{ZT2}	α _{VZ}
			V	mA		μA	V	Ω		%/°C
			NOM.			MAX.		MAX.	MAX.	TYP.
MMSZ5225	C.0	C0	3	20	0.25	50	1	30	1600	-0.06
MMSZ5226	D.6	D6	3.3	20	0.25	25	1	28	1600	-0.057
MMSZ5227	D.7	D7	3.6	20	0.25	15	1	24	1700	-0.056
MMSZ5228	D.8	D8	3.9	20	0.25	10	1	23	1900	-0.045
MMSZ5229	D.9	D9	4.3	20	0.25	5	1	22	2000	-0.029
MMSZ5230	D.0	D0	4.7	20	0.25	5	2	19	1900	0.00
MMSZ5231	E.6	E6	5.1	20	0.25	5	2	17	1600	0.00
MMSZ5232	E.7	E7	5.6	20	0.25	5	3	11	1600	0.032
MMSZ5233	E.8	E8	6	20	0.25	5	3.5	7	1600	0.035
MMSZ5234	E.9	E9	6.2	20	0.25	5	4	7	1000	0.039
MMSZ5235	E.0	E0	6.8	20	0.25	3	5	5	750	0.045
MMSZ5236	F.6	F6	7.5	20	0.25	3	6	6	500	0.052
MMSZ5237	F.7	F7	8.2	20	0.25	3	6.5	8	500	0.056
MMSZ5238	F.8	F8	8.7	20	0.25	3	6.5	8	600	0.058
MMSZ5239	F.9	F9	9.1	20	0.25	3	7	10	600	0.060
MMSZ5240	F.0	F0	10	20	0.25	3	8	17	600	0.064
MMSZ5241	H.6	H6	11	20	0.25	2	8.4	22	600	0.067
MMSZ5242	H.7	H7	12	20	0.25	1	9.1	30	600	0.070
MMSZ5243	H.8	H8	13	9.5	0.25	0.5	9.9	13	600	0.073
MMSZ5244	H.9	H9	14	9	0.25	0.1	10	15	600	0.076
MMSZ5245	H.0	H0	15	8.5	0.25	0.1	11	16	600	0.078
MMSZ5246	J.6	J6	16	7.8	0.25	0.1	12	17	600	0.080
MMSZ5247	J.7	J7	17	7.4	0.25	0.1	13	19	600	0.081
MMSZ5248	J.8	J8	18	7	0.25	0.1	14	21	600	0.082
MMSZ5249	J.9	J9	19	6.6	0.25	0.1	14	23	600	0.083
MMSZ5250	J.0	J0	20	6.2	0.25	0.1	15	25	600	0.084
MMSZ5251	K.6	K6	22	5.6	0.25	0.1	17	29	600	0.085
MMSZ5252	K.7	K7	24	5.2	0.25	0.1	18	33	600	0.087
MMSZ5253	K.8	K8	25	5	0.25	0.1	19	35	600	0.088
MMSZ5254	K.9	K9	27	4.6	0.25	0.1	21	41	600	0.09
MMSZ5255	K.0	K0	28	4.5	0.25	0.1	21	44	600	0.091
MMSZ5256	M.6	M6	30	4.2	0.25	0.1	23	49	600	0.092
MMSZ5257	M.7	M7	33	3.8	0.25	0.1	25	58	700	0.092
MMSZ5258	M.8	M8	36	3.4	0.25	0.1	27	70	700	0.093
MMSZ5259	M.9	M9	39	3.2	0.25	0.1	30	80	800	0.094
MMSZ5260	M.0	M0	43	3	0.25	0.1	33	93	900	0.095
MMSZ5261	N.6	N6	47	2.7	0.25	0.1	36	105	1000	0.095
MMSZ5262	N.7	N7	51	2.5	0.25	0.1	39	125	1100	0.096
MMSZ5263	N.8	N8	56	2.2	0.25	0.1	43	150	1300	0.096
MMSZ5264	N.9	N9	60	2.1	0.25	0.1	46	170	1400	0.097
MMSZ5265	N.0	N0	62	2	0.25	0.1	47	185	1400	0.097
MMSZ5266	P.6	P6	68	1.8	0.25	0.1	52	230	1600	0.097
MMSZ5267	P.7	P7	75	1.7	0.25	0.1	56	270	1700	0.098

Notes

- Maximum V_F = 0.9 V, at I_F = 10 mA
- (1) Measured with device junction in thermal equilibrium with typ. R_{thJA} of 370 K/W



TYPICAL CHARACTERISTICS (T_{amb} = 25 °C, unless otherwise specified)

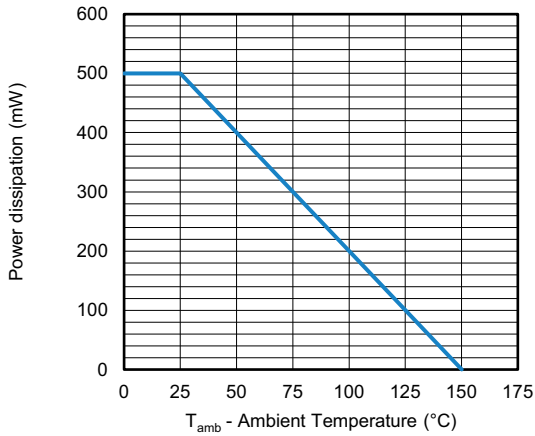

Fig. 1 - Admissible Power Dissipation vs. Ambient Temperature

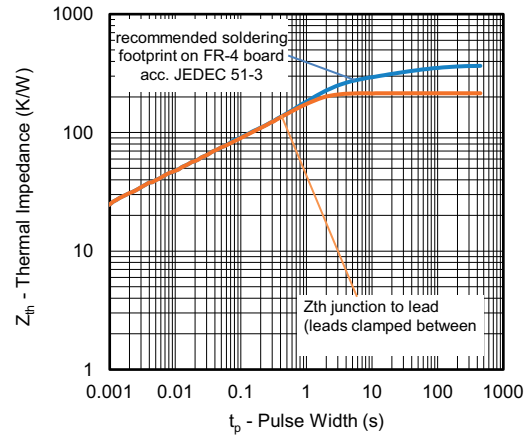
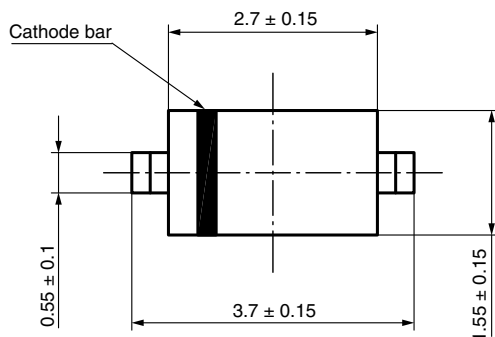
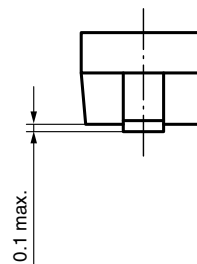
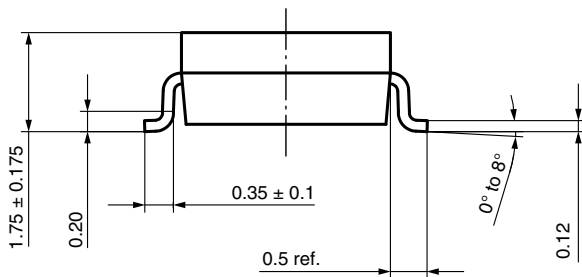
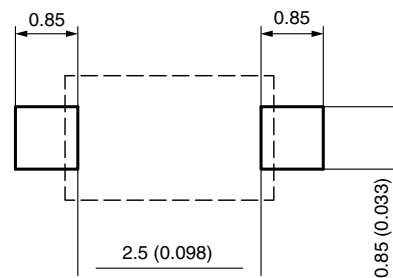

Fig. 2 - Thermal Impedance vs. Time

PACKAGE DIMENSIONS in millimeters (inches): SOD-123



Mounting Pad Layout



Created - Date: 18.Oct.2021
Rev. 01 - Date: 18.Jan.2022
Document no.: S8-V-3910.01-003 (4)



ORIENTATION IN CARRIER TAPE

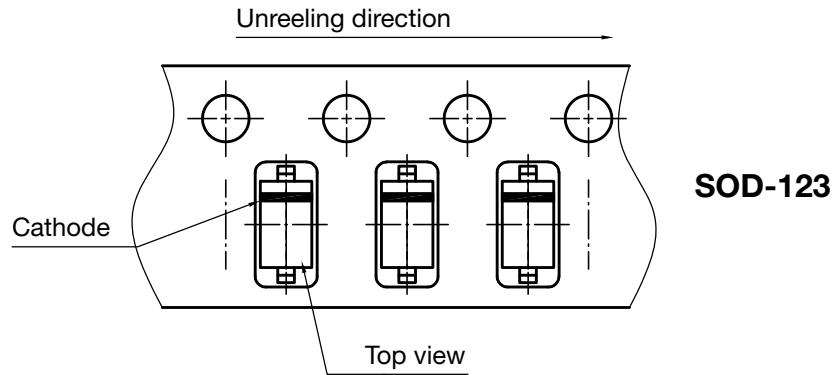

Created - Date: 09. Feb. 2016
 Rev. 01 - Date: 07. Nov. 2022
 Document no.: S8-V-3717.10-003 (4)

CARRIER TAPE

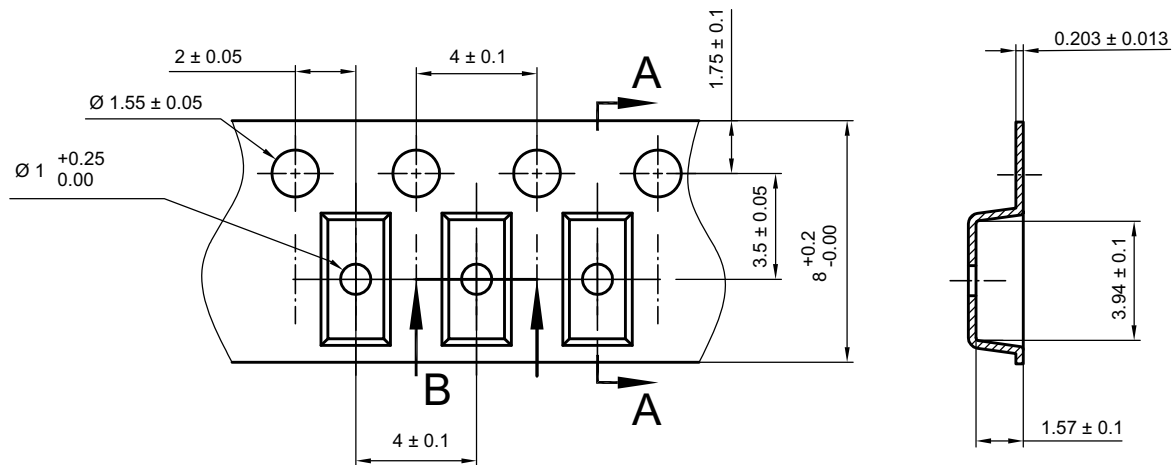

B-B Section

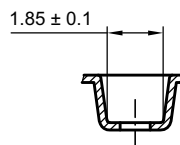

Created - Date: 07. Feb. 2013
 Rev. 01 - Date: 01. Mar. 2014
 Document no.: S8-V-3717.10-003 (4)



Disclaimer

ALL PRODUCT, PRODUCT SPECIFICATIONS AND DATA ARE SUBJECT TO CHANGE WITHOUT NOTICE TO IMPROVE RELIABILITY, FUNCTION OR DESIGN OR OTHERWISE.

Vishay Intertechnology, Inc., its affiliates, agents, and employees, and all persons acting on its or their behalf (collectively, "Vishay"), disclaim any and all liability for any errors, inaccuracies or incompleteness contained in any datasheet or in any other disclosure relating to any product.

Vishay makes no warranty, representation or guarantee regarding the suitability of the products for any particular purpose or the continuing production of any product. To the maximum extent permitted by applicable law, Vishay disclaims (i) any and all liability arising out of the application or use of any product, (ii) any and all liability, including without limitation special, consequential or incidental damages, and (iii) any and all implied warranties, including warranties of fitness for particular purpose, non-infringement and merchantability.

Statements regarding the suitability of products for certain types of applications are based on Vishay's knowledge of typical requirements that are often placed on Vishay products in generic applications. Such statements are not binding statements about the suitability of products for a particular application. It is the customer's responsibility to validate that a particular product with the properties described in the product specification is suitable for use in a particular application. Parameters provided in datasheets and / or specifications may vary in different applications and performance may vary over time. All operating parameters, including typical parameters, must be validated for each customer application by the customer's technical experts. Product specifications do not expand or otherwise modify Vishay's terms and conditions of purchase, including but not limited to the warranty expressed therein.

Hyperlinks included in this datasheet may direct users to third-party websites. These links are provided as a convenience and for informational purposes only. Inclusion of these hyperlinks does not constitute an endorsement or an approval by Vishay of any of the products, services or opinions of the corporation, organization or individual associated with the third-party website. Vishay disclaims any and all liability and bears no responsibility for the accuracy, legality or content of the third-party website or for that of subsequent links.

Except as expressly indicated in writing, Vishay products are not designed for use in medical, life-saving, or life-sustaining applications or for any other application in which the failure of the Vishay product could result in personal injury or death. Customers using or selling Vishay products not expressly indicated for use in such applications do so at their own risk. Please contact authorized Vishay personnel to obtain written terms and conditions regarding products designed for such applications.

No license, express or implied, by estoppel or otherwise, to any intellectual property rights is granted by this document or by any conduct of Vishay. Product names and markings noted herein may be trademarks of their respective owners.