

Powerex, Inc., 173 Pavilion Lane, Youngwood, Pennsylvania 15697 (724) 925-7272
www.pwr.com

POW-R-BLOK™
Single SCR Isolated Module
500 Amperes / Up to 1600 Volts

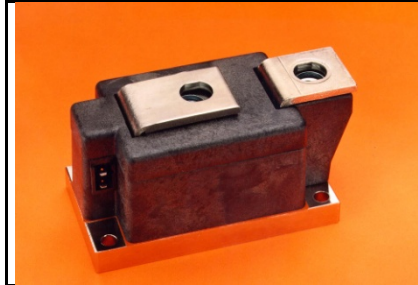
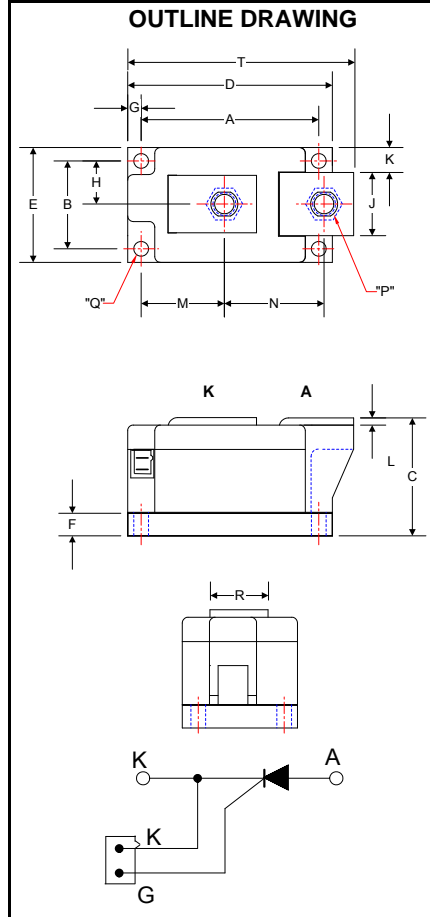

LS43__50
Single SCR
POW-R-BLOK™ Module
500 Amperes / Up to 1600 Volts

LS43 Outline Dimensions

| Dimension | Inches | Millimeters |
|-----------|--------------|-------------|
| A | 3.15 | 80.0 |
| B | 1.50 | 38.0 |
| C | 2.05 | 52.1 |
| D | 3.62 | 92.0 |
| E | 1.97 | 50.0 |
| F | 0.39 | 9.9 |
| G | 0.24 | 6.1 |
| H | 0.75 | 19.0 |
| J | 0.99 | 25.1 |
| K | 0.48 | 12.2 |
| L | 0.12 | 3.1 |
| M | 1.45 | 36.8 |
| N | 1.76 | 44.7 |
| P | M10 Metric | M10 |
| Q | 0.250 Dia. | 6.35 Dia. |
| R | 0.99 | 25.1 |
| S | 0.110 x .032 | 2.5 x 0.8 |
| T | 3.99 | 101.3 |

Note: Dimensions are for reference only.

Ordering Information:

Select the complete eight-digit module part number from the table below.

Example: LS431650 is a 1600 Volt, 500 Ampere Single SCR Isolated POW-R-BLOK™ Module

| Type | Voltage Volts (x100) | Current Amperes (x10) |
|------|----------------------|-----------------------|
| LS43 | 08 | 50 |
| | 10 | |
| | 12 | |
| | 14 | |
| | 16 | |

Description:

Powerex Single SCR Modules are designed for use in applications requiring rectification and isolated packaging. The modules are isolated for easy mounting with other components on a common heatsink. POW-R-BLOK™ has been tested and recognized by the Underwriters Laboratories.

Features:

- Electrically Isolated Heatsinking
- Aluminum Nitride Insulator
- Compression Bonded Elements
- Metal Baseplate
- Low Thermal Impedance for Improved Current Capability
- Quick Connect Gate Terminal with Provision for Keyed Mating Plug
- UL Recognized

Benefits:

- No Additional Insulation Components Required
- Easy Installation
- No Clamping Components Required
- Reduce Engineering Time

Applications:

- Bridge Circuits
- AC & DC Motor Drives
- Battery Supplies
- Power Supplies
- Large IGBT Circuit Front Ends

Absolute Maximum Ratings

| Characteristics | Conditions | Symbol | Units |
|---|---|-----------------------|---------------------------------------|
| Repetitive Peak Forward and Reverse Blocking Voltage | | V_{DRM} & V_{RRM} | up to 1600 V |
| Non-Repetitive Peak Blocking Voltage ($t < 5$ msec) | | V_{RSM} | $V_{RRM} + 100$ V |
| RMS Forward Current | 180° Conduction, $T_C=78^\circ\text{C}$ | $I_{T(RMS)}$ | 900 A |
| Average Forward Current | 180° Conduction, $T_C=86^\circ\text{C}$ | $I_{T(AV)}$ | 500 A |
| | 180° Conduction, $T_C=78^\circ\text{C}$ | $I_{T(AV)}$ | 575 A |
| Peak One Cycle Surge Current, Non-Repetitive | 60 Hz, 100% V_{RRM} reapplied | I_{TSM} | 17,000 A |
| | 50 Hz, 100% V_{RRM} reapplied | I_{TSM} | 16,300 A |
| Peak Three Cycle Surge Current, Non-Repetitive | 60 Hz, 100% V_{RRM} reapplied | I_{TSM} | 12,250 A |
| Peak Ten Cycle Surge Current, Non-Repetitive | 60 Hz, 100% V_{RRM} reapplied | I_{TSM} | 10,500 A |
| I^2t for Fusing for One Cycle | 8.3 milliseconds | I^2t | 1.20×10^6 A ² sec |
| | 10 milliseconds | I^2t | 1.33×10^6 A ² sec |
| Maximum Rate-of-Rise of On-State Current, (Repetitive) | Per JEDEC Standard 397 5.2.2.6 | di/dt | 200 A/ μ s |
| Operating Temperature | | T_J | -40 to +130 °C |
| Storage Temperature | | T_{stg} | -40 to +150 °C |
| Max. Mounting Torque, M6 Mounting Screw | | | 55 in. – Lb. |
| | | | 6 Nm |
| Max. Mounting Torque, M10 Terminal Screw | | | 110 in. – Lb. |
| | | | 12 Nm |
| Module Weight, Typical | | | 816 g |
| | | | 1.80 lb |
| V Isolation @ 25C | | V_{rms} | 3000 V |

Information presented is based upon manufacturers testing and projected capabilities.
 This information is subject to change without notice.
 The manufacturer makes no claim as to the suitability of use, reliability, capability,
 or future availability of this product.

Electrical Characteristics, T_J=25°C unless otherwise specified

| Characteristics | Symbol | Test Conditions | Min. | Max. | Units |
|--|--------------------|---|--------------------------|---|-------|
| Repetitive Peak Forward Leakage Current | I _{DRM} | Up to 1600V, T _J =130°C | | 80 | mA |
| Repetitive Peak Reverse Leakage Current | I _{RDM} | Up to 1600V, T _J =130°C | | 80 | mA |
| Peak On-State Voltage | V _{FM} | I _{TM} =1500A | | 1.30 | V |
| Threshold Voltage, Low-level | V _{(TO)1} | T _J = 130°C, I = 15%I _{T(AV)} to πI _{T(AV)} | | 0.81 | V |
| Slope Resistance, Low-level | r _{T1} | | | 0.32 | mΩ |
| Threshold Voltage, High-level | V _{(TO)2} | T _J = 130°C, I = πI _{T(AV)} to I _{TSM} | | 0.90 | V |
| Slope Resistance, High-level | r _{T2} | | | 0.26 | mΩ |
| V _{TM} Coefficients, Full Range | | T _J = 130°C, I = 10A to 6kA V _{TM} = A + B Ln I + C I + D Sqrt I | A = B = C = D = | 0.8824 -4.46E-02 8.12E-05 1.54E-02 | |
| Minimum dV/dt | dV/dt | Exponential to V _{DRM} T _J =130°C, Gate Open | 1000 Typ. | | V/μs |
| Gate Trigger Current | I _{GT} | T _J =25°C, V _D =12V | | 200 | mA |
| Gate Trigger Voltage | V _{GT} | T _J =25°C, V _D =12V | | 3.0 | Volts |
| Non-Triggering Gate Voltage | V _{GDM} | T _J =130°C, V _D = ½ V _{DRM} | | 0.25 | Volts |
| Peak Forward Gate Current | I _{GTM} | | | 4.0 | Amp |
| Peak Reverse Gate Voltage | V _{GRM} | | | 5 | Volts |

Thermal Characteristics

| Characteristics | Symbol | | Max. | Units |
|---|-------------------|--|--|--|
| Thermal Resistance, Junction to Case | R _{ΘJ-C} | Per Module/Junction | 0.0650 | °C/W |
| Thermal Impedance Coefficients | Z _{ΘJ-C} | Z _{ΘJ-C} = K ₁ (1-exp(-t/τ ₁)) + K ₂ (1-exp(-t/τ ₂)) + K ₃ (1-exp(-t/τ ₃)) + K ₄ (1-exp(-t/τ ₄)) | K ₁ = 8.03E-04 K ₂ = 1.03E-02 K ₃ = 1.64E-02 K ₄ = 3.75E-02 | τ ₁ = 3.39E-04 τ ₂ = 3.15E-03 τ ₃ = 0.106 τ ₄ = 2.066 |
| Thermal Resistance, Case to Sink Lubricated | R _{ΘC-S} | Per Module | 0.02 | °C/W |

Maximum On-State Forward Voltage Drop
($T_j = 130^\circ\text{C}$)

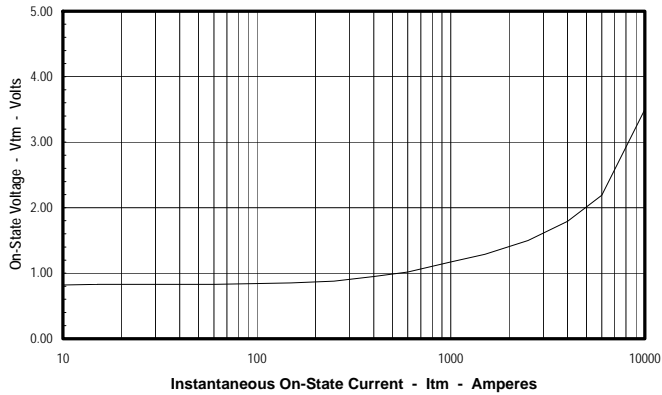

Maximum Transient Thermal Impedance
(Junction to Case)

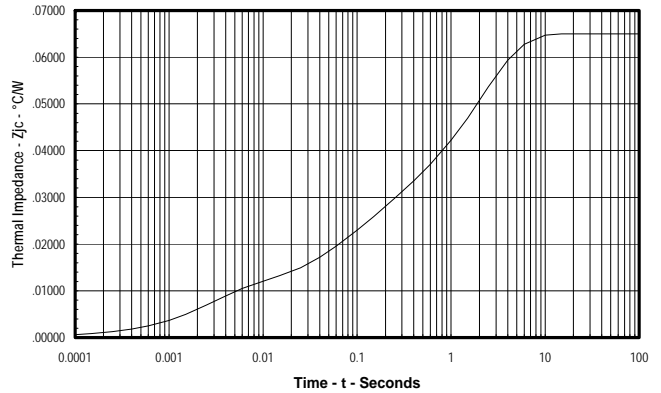

Maximum On-State Power Dissipation
(Sinusoidal Waveform)

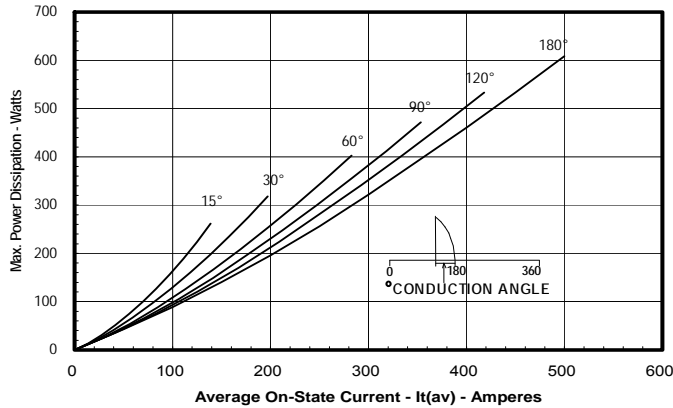

Maximum Allowable Case Temperature
(Sinusoidal Waveform)

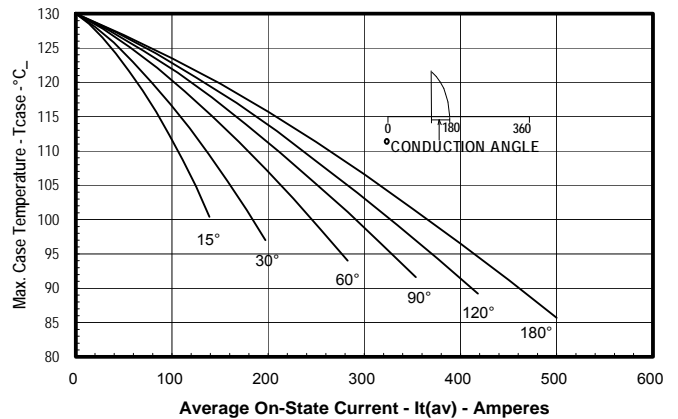

Maximum On-State Power Dissipation
(Rectangular Waveform)

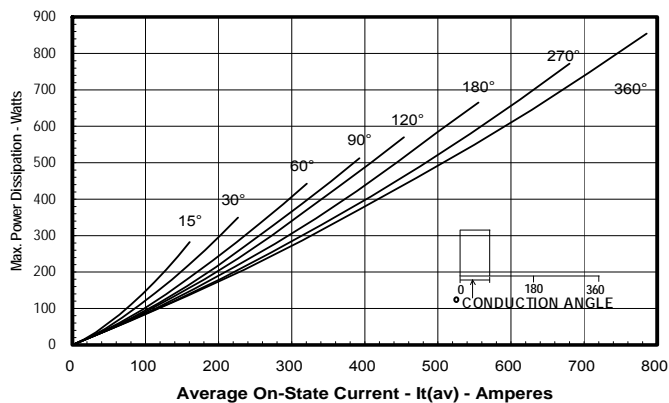

Maximum Allowable Case Temperature
(Rectangular Waveform)

