



SC2200

Serial Peripheral Interface Programming Guide

UG6336; Rev 0; 9/16

Abstract

This document provides the information necessary to develop the host software to communicate with the SC2200 by way of the Serial Peripheral Interface (SPI).

CONTENTS

1. Introduction	5
1.1. Scope	5
1.2. Acronyms	5
1.3. Revision History	5
1.4. References	6
2. SPI Host Message Interface Protocol	6
2.1. Host Write Operation to Message Interface Buffer	8
2.2. Host Read Operation from Message Interface Buffer	9
2.3. 16-byte Host Message Interface Structure	10
2.4. Host Message to Read/Write Scratch	11
2.5. Host Message to Read/Write PRAM.....	12
2.6. Host Message for Software Reset	13
2.7. Host Message to Clear/Set Calibration Parameters	13
3. Global Scratch Parameters	15
3.1. Device Info Scratch Structure	16
3.2. Firmware Status Scratch Structure	16
3.3. RF Status Scratch Structure	17
3.4. Firmware Debugging Information Scratch Structure.....	17
3.5. PMU Scratch Structure	18
4. Reprogramming the EEPROM with Updated Firmware and Application Parameters	19
4.1. EEPROM Mapping and Application Parameters	19
4.2. FwConfigPath Structure	22
4.3. Device Configuration Structure	23
4.4. CAL Parameter Structure	23
4.5. Device Advanced Configuration Structure	24
4.6. Performance Tuning Parameters	25
4.7. Meeting Spectral Emission Limits Very Close to Carrier	26
4.8. EEPROM Write Instruction.....	27
4.9. EEPROM Read Instruction	30
4.10. EEPROM Endurance	30
5. PRAM Application Parameters	31
5.1. To Enable/Disable Correction with PRAM parameter	31
5.2. To Freeze/UnFreeze Adaptation with PRAM parameter	32
5.3. To Read back Adaptation State and Correction Enable from PRAM	33
6. 16-byte Host Message Interface Examples	34
6.1. SC2200_Clear_Calibration	34
6.2. SC2200_Set_Calibration.....	34
6.3. Reading Device Information from Scratch	35
6.4. Reading Path A/B FW Status from Scratch	35
6.5. Reading Device FW Debug Information from Scratch.....	36
6.6. Clear Info Stack.....	36
6.7. Read RFIN and RFFB AGC Values	37
6.8. Read RFIN and RFFB PMU Values	37

7. Matlab Example Codes	38
7.1. SC2200_Read_ApplicationParameters (From EEPROM).....	38
7.2. SC2200_SetFrequencyScan (In EEPROM)	41
7.3. SC2200_SetClockRef (In EEPROM)	43
7.4. SC2200_Get_Device_Information (From Scratch)	43
7.5. SC2200_Get_Device_FW_Status	44
7.6. SC2200_Get_Paths_Status (From Scratch and PRAM)	45
7.7. SC2200_Clear_Calibration	47
7.8. SC2200_Set_Calibration.....	48
7.9. Clear InfoStack.....	48
7.10. Convert16B_Signed SC2200 (PRAM, Scratch and EEPROM)	48

List of Tables

Table 1: Host Write Operation to Message Interface Buffer.....	8
Table 2: Host Read Operation from Message Interface Buffer	9
Table 3: Host 16-byte Message Structure	10
Table 4: SC2200 16-byte Reply Message Structure	10
Table 5: Host 16-byte Message to Read/Write Scratch Parameters	11
Table 6: Host 16-byte Message to Read/Write Scratch Parameters	12
Table 7: Host 16-byte Message for Soft Reset	13
Table 8: Host 16-byte Message to Clear/Set Calibration Parameters	13
Table 9: SC2200 16-byte Reply Message to Clear/Set Calibration Parameters	13
Table 10: Global Scratch parameters available via SPI Messages	15
Table 11: Device Info Structure	16
Table 12: FW Status Structure	16
Table 13: RF Status Structure.....	17
Table 14: Firmware Debugging Information Structure	17
Table 15: Error Stack Structure	17
Table 16: Info Stack Structure	17
Table 17: Error Code Descriptions	17
Table 18: Information Code Descriptions	18
Table 19: PMU Structure	18
Table 20: EEPROM Mapping	19
Table 21: EEPROM addresses for Application parameters	20
Table 22: FwConfigPath Structure	22
Table 23: Device Configuration Structure	23
Table 24: CAL Parameter Structure	23
Table 25: Advanced Device Configuration Structure.....	24
Table 26: Performance Tuning Parameters	25
Table 27: SC2200 EEPROM Endurance	30

List of Figures

- Figure 1: Host SPI Message Protocol Flow Diagram..... 7
- Figure 2: Host Write Operation to Message Interface..... 8
- Figure 3: Host Read Operation from Message Interface 9
- Figure 4: EEPROM Mapping Capture from GUI ACCP Config tab..... 21
- Figure 5: Guard Band Region 26

1. Introduction

1.1. Scope

This document provides the information necessary to develop the host software to communicate with the SC2200 via the Serial Peripheral Interface (SPI) interface.

1.2. Acronyms

Acronyms	Description
AGC	Automatic Gain Control
EEPROM	Electrically Erasable, Programmable, Read-Only Memory
EVB	Evaluation Board
PAR	Peak-to-Average Ratio
PVT	Process, Voltage and Temperature.
RFFB	RF Feedback
RFIN	RF Input
RFOUT	RF Output
RFPAL	RF PA Linearization
SBW	Signal Bandwidth
SPI	Serial Peripheral Interface
SSN	SPI Slave Select Enable
XTAL	Crystal

1.3. Revision History

Revision	Description
0.5	Preliminary version
0.8	Added instruction to read and write to PRAM Application parameters. Add Clear/Set Calibration and Soft Reset commands. Fix errors on Scratch mapping. Added example code for Convert16B_signed_SC2200. Updated EEPROM write instructions from 64-bytes to 128-bytes per page.
0.9	Added AdaptOnTime_10ms parameter. Updated example codes.
1.0	Added Scratch and EEPROM/PRAM parameters.
1.1	Based on firmware 5.0.09.04, updated Clear/Set Calibration commands, EEPROM and Scratch mappings and Matlab example codes. Added Info Stack and Clear Info Stack commands, 16-byte host message examples and Performance tuning parameters.
1.2	Fixed some errors in RF status and PMU structures. Added host SPI command to read RFIN and RFFB AGC and PMU values.
1.3	Fixed error in Info Stack offset. Updated performance tuning section and added section on performance optimization with the guard band parameter. Added clarification to read/write procedure to EEPROM.
1.4	General edits to remove requirement for NDA to access SC2200 collateral.

1.4. References

Document	NDA Required
SC2200 Hardware Design Guide	YES
SC2200 Release Notes	NO
SC2200 SPI Programming Guide	YES
SC2200 Data Sheet	NO

2. SPI Host Message Interface Protocol

The SPI host message interface protocol allows reading and writing to scratch and PRAM parameters. As described in Figure 1, the SPI host message protocol flow is as follow:

1. Host composes 16-byte message with compute checksum as described in section 2.3
2. Retry = 0
3. The host write message to the message interface buffer as described in section 1
4. Wait 200 μ s
5. Host Read message from the 16-byte reply message from the message interface buffer as described in Section 2.2
6. Timer = 0
7. Wait 200 μ s
8. While (ACK_byte = 0 && Timer < 5)
 - a. Wait 200 μ s
 - b. Timer = Timer + 1
 - c. Host Read message from the 16-byte reply message from the message interface buffer
9. Endwhile
10. if (ACK_byte == 0 && Timer=5)
 - a. Retry = Retry + 1;
 - b. If Retry < 2 Go back to step 3
11. Endif
12. If (ACK_byte! = 1)
 - a. Retry = Retry + 1;
 - b. If Retry < 2 Go back to step 3
13. Host read message checksum and compute replay message checksum (See section 2.2)
14. If computed checksum = read checksum,
15. Host message protocol is completed.
16. Else
17. Retry = Retry + 1;
18. If Retry < 2 Go back to step 3
19. Endif

IMPORTANT: *Retry = 2 and Timeout (1ms) of the Timer should not happen under normal conditions. If any of these conditions occurs, then*

- a. Check that the part is drawing current
- b. Check the SPI interface

c. Try to increase the timer and the Retry limit until it is stable and let Maxim Integrated support team know.

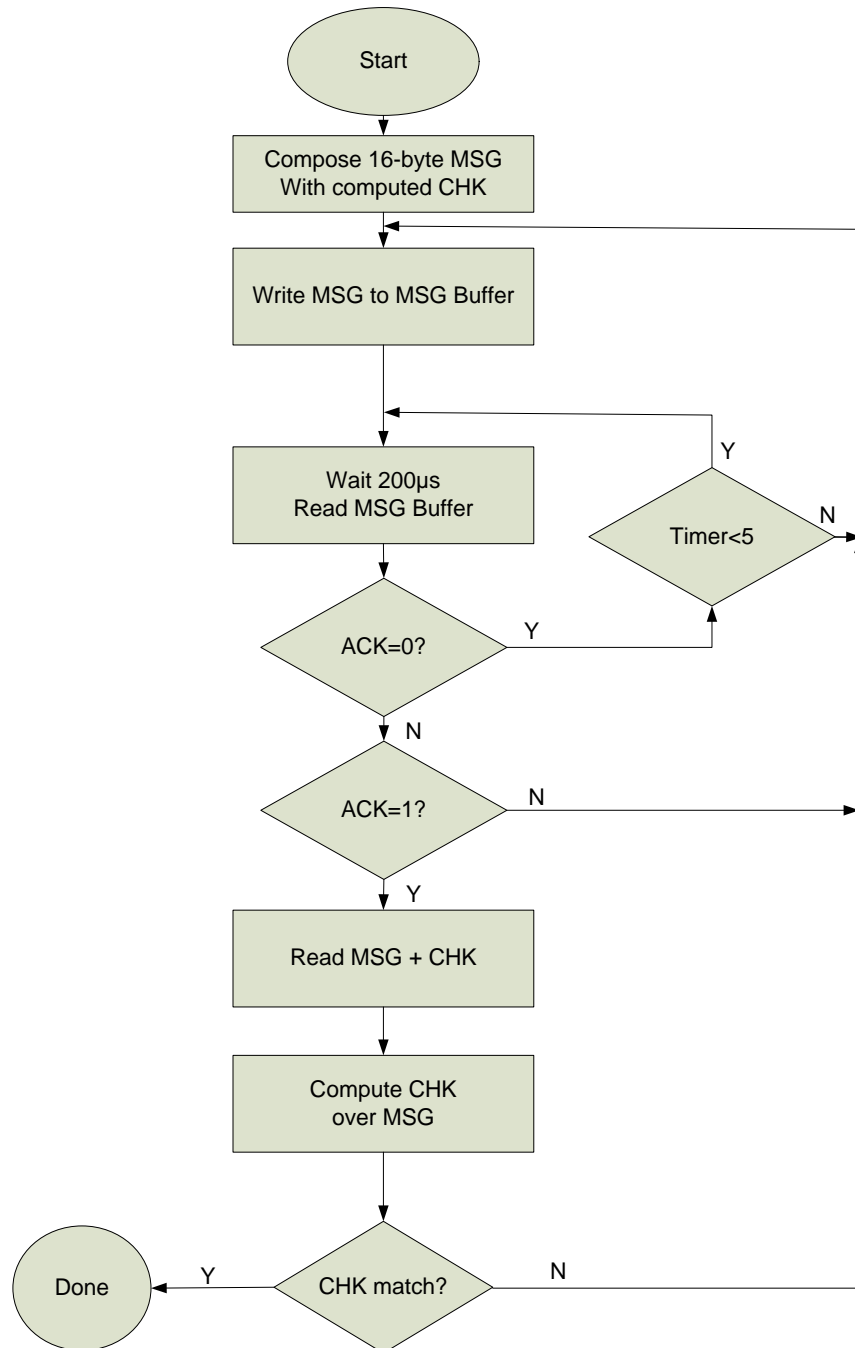

Figure 1. Host SPI Message Protocol Flow Diagram

2.1. Host Write Operation to Message Interface Buffer

The host writes the 16-byte message to the message interface buffer, as described in

Table 1 and Figure 2.

The Host 16-byte message structure is defined in section 2.3.

Table 1: Host Write Operation to Message Interface Buffer

Byte	0	1		2	3 to 18
Bits	A15-A8	A7-A0		A19-A16 R/W bit	
Value	20	40		20	Host Message Bytes 0 to 15

Host Sending on SDI

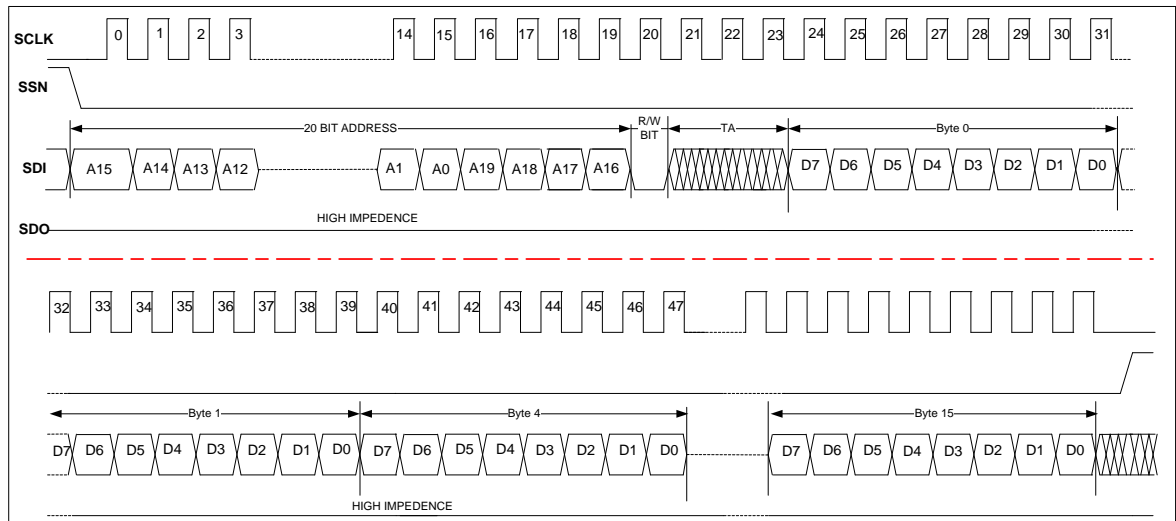

Figure 2: Host Write Operation to Message Interface

2.2. Host Read Operation from Message Interface Buffer

The host reads the 16-byte message reply from the Message Interface Buffer as described in Table 2 and Figure 3.

The SC2200 16-byte reply message structure is defined in section 2.3.

Table 2: Host Read Operation from Message Interface Buffer

Byte	0	1	2	3 to 18
Bits	A15-A8	A7-A0	A19-A16 R/W bit	
Value	20	40	2B	SC2200 Message Reply Byte 0 to 15

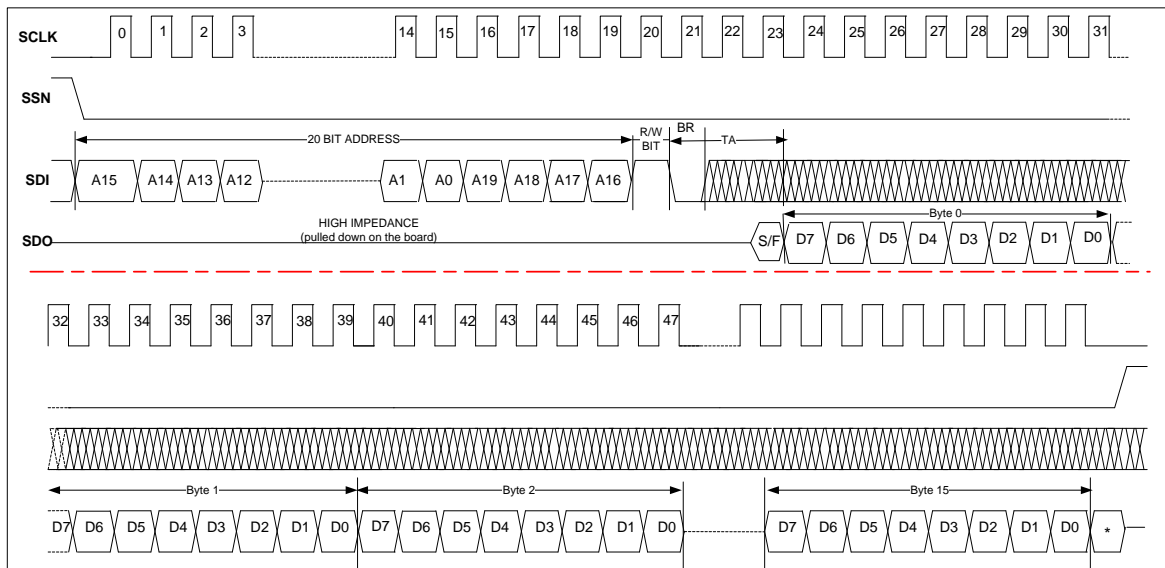
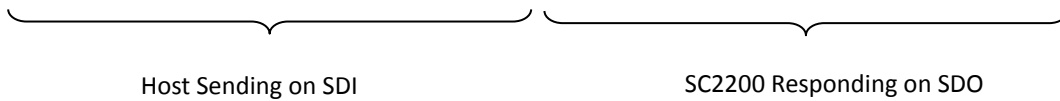

Figure 3: Host Read Operation from Message Interface

2.3. 16-byte Host Message Interface Structure

This section describes the Host 16-byte message structure and the SC2200 16-byte reply message structure. Table 3 describes the host 16-byte message structure.

Table 3: Host 16-byte Message Structure

Byte	0	1	2-14	15
Value	CS	OP	Opcode Specific	ACK

- CS = bitxor checksum of the other 15 bytes. See computation below.
 - checksum = uint8(0);
 - for I = 1:15
 - checksum = bitxor(uint8 (checksum), uint8 (byte(i)));
 - end
- OP = Opcode
 - 0: Read from Scratch
 - 1: Write to Scratch
 - 4: Read from PRAM
 - 5: Write to PRAM
 - 6: Software Reset
 - 7: Clear Calibration Data
 - 8: Set Calibration Data
- Opcode specific bytes (2 to 14). See each Opcode structure for details.
- ACK = 0

Table 4 describes the SC2200 16-byte reply message structure.

Table 4: SC2200 16-Byte Reply Message Structure

Byte	0	1	2	3	4	5	6	7	8	9	10	11	12	13	14	15
Value	CS	B0	B1	B2	B3	B4	B5	B6	B7	B8	B9	B10	B11	B12	B13	ACK

- CS = bitxor checksum of the other 15 bytes.
 - checksum = uint8(0);
 - for i=1:15
 - checksum = bitxor(uint8 (checksum), uint8 (byte(i)));
 - end
- B0-B13
 - For Write Operation, all set to = 0
 - For Read Operation = up to 14-bytes read
- ACK =
 - 1 = Successful
 - 2 = Invalid Checksum
 - 3 = MSG not supported
 - 4 = Invalid location
 - 5 = Invalid number of bytes requested
 - 6 – 255 Reserved

2.4. Host Message to ReadGF/Write Scratch

This section describes the Host 16-byte message structure and the SC2200 16-byte reply message structure to read and write scratch parameters.

Table 5: Host 16-Byte Message to Read/Write Scratch Parameters

Byte	0	1	2	3	4	5	6	7	8	9	10	11	12	13	14	15
Value	CS	OP	Addr MSB	Addr LSB	SZ	Zone	B0	B1	B2	B3	B4	B5	B6	B7	B8	ACK

- CS = bitxor checksum of the other 15 bytes. See computation in section 2.4
- OP = Opcode
 - 0 to read from Scratch
 - 1 to write to Scratch
- Addr MSB = Scratch address most significant byte
- Addr LSB = Scratch address least significant byte
- SZ = number of bytes to read or write
- Zone = 0
- B0-B8
 - For read, all set to = 0
 - For Write = 9-bytes to be written
- ACK = 0

The SC2200 16-byte reply message structure is described in Table 4

See section 3 for the different scratch parameters addresses.

Below is an example to read from Scratch the 7-byte of the Device Info (See Table 11 for Device Info Structure details)

16-byte Command written to the Message Interface Buffer: 71 0 64 0 7 0 0 0 0 0 0 0 0 0 0 0

CS = 71 = 0x47

OP = 0

Addr MSB = 64 = 0x40

Addr LSB = 0

SZ = 7 bytes to read

16-byte Response read from the Message Interface Buffer: 151 83 80 5 0 0 8 152 0 0 0 0 0 0 0 0 1

CS = 151 = 0x97

B0 = 83 = HW Version

B1 = 80 = 0x5 FW Version

B2 = 5 = FW Build

B3 = 0 = FW Hot Build

B4 = 0 = Product Feature Option

B5 = 8 ,B6 = 152. $8 * 256 + 152 = 2200 = \text{Firmware Product Version}$

B7 to B13: don't care.

ACK = 1 = Successful

2.5. Host Message to Read/Write PRAM

This section describes the Host 16-byte message structure and the SC2200 16-byte reply message structure to read and write PRAM parameters.

Table 6: Host 16-byte Message to Read/Write Scratch Parameters

Byte	0	1	2	3	4	5	6	7	8	9	10	11	12	13	14	15
Value	CS	OP	Addr MSB	Addr LSB	SZ	B0	B1	B2	B3	B4	B5	B6	B7	B8	B9	ACK

- CS = bitxor checksum of the other 15 bytes. See computation in section 2.4
- OP = Opcode
 - 4 to read from PRAM
 - 5 to write to PRAM
- Addr MSB = Scratch address most significant byte. Same address mapping as Application parameters in EEPROM as described in Table 21.
- Addr LSB = Scratch address least significant byte
- SZ = number of bytes to read or write
- B0-B9
 - For read, all set to = 0
 - For Write = 10-bytes to be written
- ACK = 0

The SC2200 16-byte reply message structure is described in Table 13.

For example, to read the first 4-bytes of the application parameters in PRAM

Command written to the Message Interface Buffer: 252 4 252 0 4 0 0 0 0 0 0 0 0 0 0 0

CS = 252

OP = 4 to read from PRAM

Addr MSB = 252, Addr LSB = 0. Address = 252 * 256 = 0xFC00.

SZ = 4-bytes to read.

Response read from the Message Interface Buffer: 72 20 80 21 24 0 0 0 0 0 0 0 0 0 0 1

CS = 72

B0 = 20, B1 = 80. $(20*256+80)/2 = 5200/2 = 2600\text{MHz}$

B2 = 21, B3 = 24. $(21*256+24)/2 = 5400/2 = 2700\text{MHz}$

ACK = 1

2.6. Host Message for Software Reset

This section describes the Host 16-byte message structure for Software Reset. Software Reset allows to reset the firmware without resetting the internal driver.

Table 7: Host 16-byte Message for Soft Reset

Byte	0	1	2-14	15
Value	CS	OP	X	0

- CS = bitxor checksum of the other 15 bytes = 6 if X = 0 for Bytes 2 to 14.
- OP = 6
- Bytes 2 to 14 values are not critical, but must be sent. So recommend using “0”

Command buffer sent to Antares: 6 6 0 0 0 0 0 0 0 0 0 0 0 0 0 0.
No Response from SC2200 to Soft Reset Command

2.7. Host Message to Clear/Set Calibration Parameters

This section describes the Host 16-byte message structure and the SC2200 16-byte reply message structure to Clear/Set Calibration Parameters.

Table 8: Host 16-byte Message to Clear/Set Calibration Parameters

Byte	0	1	2	3	4	5	6	7	8	9	10	11	12	13	14	15
Value	CS	OP	Path	0	X	X	X	X	X	X	X	X	X	X	X	0

- CS = bitxor checksum of the other 15 bytes. See computation in section 2.4
- OP = Opcode
 - 7: Clear Calibration Data
 - 8: Set Calibration Data
- Path: A = 0 and B = 1

Table 9: SC2200 16-byte Reply Message to Clear/Set Calibration Parameters

Byte	0	1	2	3	4	5	6	7	8	9	10	11	12	13	14	15
Value	CS	0	0	0	0	0	0	0	0	0	0	0	0	0	0	ACK

- CS = bitxor checksum of the other 15 bytes. See computation in section 2.4
- ACK = 1 = Successful
 - 2 = Invalid Checksum
 - 3 = MSG not supported
 - 4 = Invalid location
 - 5 = Invalid number of bytes requested
 - 6 – 255 Reserved

To Clear Calibration data, the following Command is written to the Message Interface Buffer:
7 7 0 0 0 0 0 0 0 0 0 0 0 0 0 0

with CS = 7 = OP = 7.

Need to read Response from the Message Interface Buffer until the following is read:

1 1 0 0 0 0 0 0 0 0 0 0 0 0 0 1

To Set Calibration data, the following Command is written to the Message Interface Buffer:

8 8 0 0 0 0 0 0 0 0 0 0 0 0 0 0

with CS = 8 = OP = 8.

Need to read Response from the Message Interface Buffer until the following is read:

1 0 0 0 0 0 0 0 0 0 0 0 0 0 0 1

IMPORTANT

- a. *It is recommended to Reset after Clear or Set Calibration (Hardware or SoftReset)*
- b. *Before sending Set Calibration data, please wait for acceptable performance.*

3. Global Scratch Parameters

The host can read or write to the Global scratch parameters described in this section via the message protocol described in section 2.3. Please refer to Figure 1 for Host Flow Diagram and sections 7.4 and 7.5 for example code to read Scratch parameters.

Table 10: Global Scratch Parameters Available Via SPI Messages

Scratch Address (Hex)	Variable Name	Description
4000	Device Info	Device Info Structure. See Table 11 for detail.
403A	FW Status Path A	FW Status for path A. See Firmware Status Scratch Structure Table 12 for detail.
4048	FW Status Path B	FW Status for path B. See Firmware Status Scratch Structure Table 12 for detail.
4056	RF Status Path A	RF Status Structure for path A. See RF Status Scratch Structure Table 13 for detail.
4068	RF Status Path B	RF Status Structure for path B. See RF Status Scratch Structure Table 13 for detail.
407A	FW Debug Info	Firmware Debugging information. See Table 14
40B6	PMU Path B	Power Monitoring Unit Structure for Path B. See PMU Scratch Structure Table 19 for detail.
40C4	PMU Path A	Power Monitoring Unit Structure for Path A. See PMU Scratch Structure Table 19 for detail.
4110	IcTemp Path A	Ic Temp for Path A
4176	IcTemp Path B	Ic Temp for Path B
4330	Clear Info Stack	Write 1 to clear the Info Stack. Once it reads back 0 Warnings have been cleared

IMPORTANT

- a. Global Scratch (also referred to Scratch) base address is 0x4000
- b. It is also possible to use the SC2200 GUI ACCP Config tab to read the exact scratch parameters (Scratch base address 0x4000 is not displayed in the GUI, only the offset).

3.1. Device Info Scratch Structure

Table 11: Device Info Structure

Offset (Hex)	Size/Access	Variable Name	Description
00	UINT8	HW Version	IC Version. Expected to be 83. Other values will generate an error 29.
01	UINT8	FW Version	FW version with a value of WX=0x50 displayed as 5.0
02	UINT8	FW Build	FW Build number YY associated with FW version W.X with values of WX=0x50 and YY=09 displayed as 5.0.09
03	UINT8	FW Hot Build	FW Hot Build number ZZ associated with FW version W.X and FW Build YY with values of WX=0x50, YY=09 and ZZ=04 displayed as 5.0.09.04
04	UINT8	Reserve	Reserved (DO NOT CHANGE VALUES)
05	UINT16	Firmware Product Version	Firmware Product Version. Expected to be 2200. Other values will generate an error 31.

IMPORTANT - Do not write to these registers.

See section 6.3 for the 16-byte message to the command buffer to read the Device Info Structure.

3.2. Firmware Status Scratch Structure

Table 12: FW Status Structure

Offset (Hex)	Size/Access	Variable Name	Description
000	UINT8	Status	Firmware Status 1 = VCO CAL 2 = PDET AGC 3 = PMU 4 = TRACK 5 = FROZEN 6 = FREQ_SCAN 7 = SHUTDOWN (If DeviceConfig.ShutDownTime_10ms > 0)
001	UINT8	Error Index	Index between 0 and 9 in Error stack array from FW Debugging Information. See Table 14 for detail.
002	UINT8	Info Index	Index between 0 and 9 in Info stack array from FW Debugging Information. See Table 14 for detail.
003	UINT16	Center Frequency	2xFrequency(MHz). Value of 0x1450 is 2600 MHz
005	UINT8	Signal Bandwidth	2xSignal Bandwidth(MHZ). Value of 0x28 is 20 MHz.
006		Reserved	Reserved (DO NOT CHANGE VALUES)
007	INT16	Cost Function	Current cost function power

IMPORTANT - It is recommended to periodically read the FW for general firmware status, no faster than every 100ms.

3.3. RF Status Scratch Structure

Table 13: RF Status Structure

Offset (Hex)	Size/Access	Variable Name	Description
000	UINT8	Reserved	Reserved (DO NOT CHANGE VALUES)
001	UINT8	RFFB AGC	RFFB AGC value
002	UINT8	Reserved	Reserved (DO NOT CHANGE VALUES)
003	INT16	RFIN AGC	RFIN AGC value

3.4. Firmware Debugging Information Scratch Structure

Table 14: Firmware Debugging Information Structure

Offset (Hex)	Size/Access	Variable Name	Description
000	10x3 UINT8	ErrorStack	Array with all error codes that have occurred (circular, up to 10 errors)
01E	10x3 UINT8	InfoStack	Array with all Information codes that have occurred (circular, up to 10 Informations)

Table 15: Error Stack Structure

Offset (Hex)	Size/Access	Variable Name	Description
000	UINT8	ErrorCode	Error Code. See Table 17 for error code descriptions.
001	UINT8	Path	0 = Path A; 1 = Path B; 255 = General
002	UINT8	Reserved	

Table 16: Info Stack Structure

Offset (Hex)	Size/Access	Variable Name	Description
000	UINT8	InfoCode	Information Code. See Table 18 for info code descriptions.
001	UINT8	Path	0 = Path A; 1 = Path B; 255 = General
002	UINT8	Reserved	

Table 17: Error Code Descriptions

Error Code	Description
0	No error
3	Error 3 means EEPROM customer configuration parameter corruption. See EEPROM mapping for customer configuration parameters in Table 21
9	Internal Temperature is too high (>140°C)
10	Internal Temperature is too low (<-60 °C)
29	If HW Version different than 83. See Table 11.
31	If Firmware Product Version different than 2200. See Table 11.

Table 18: Information Code Descriptions

Info Code	Description
0	No Information
12	WatchDog Reset Event. If the 8051 microcontroller has reset at any given time due to a FW timeout occurrence. This only gets cleared with hardware reset or "Clear Info" command.
14	Max Calibration RFFB Power level is below -45dBm. Please make sure components on RFFB are assembled properly. This info code will only be reported if system is calibrated with RFFB below -45dBm. This should never happen under normal conditions.
16	Max Calibration RFIN Power level is below -30dBm. Please make sure components on RFIN are assembled properly. This info code will only be reported if system is calibrated with RFIN below -30dBm. This should never happen under normal conditions.

3.5. PMU Scratch Structure

Table 19: PMU Structure

Offset (Hex)	Size/Access	Variable Name	Description
000 001	INT16	RFFB RMS	RFFB RMS Power (dBm/10ms) over a 10ms measurement window. Signed 6.10 signed dBN Value. See below for conversion from dBN to dBm value.
002 005		Reserved	Reserved (DO NOT CHANGE VALUES)
006 007	INT16	RFIN RMS	RFIN RMS Power (dBm/10ms) over a 10ms measurement window. Signed 6.10 signed dBN Value. See below for conversion from dBN to dBm value.
008 00B		Reserved	Reserved (DO NOT CHANGE VALUES)
00C 00D	INT16	PA Gain	PA Gain = (RFFB RMS – RFIN RMS) Power (dBm/10ms) over a 10ms measurement window. Signed 6.10 signed dBN Value. See below for conversion from dBN to dBm value.

Conversion from dBN to dBm as follow:

$$P_{dBm} = \frac{dBN * 3.01}{1024}$$

4. Reprogramming the EEPROM with Updated Firmware and Application Parameters

IMPORTANT - To reprogram the EEPROM with updated firmware and new application parameters, it is important to know the EEPROM mapping as described in Table 20 as the firmware download must start at address 0x0000 and not go over 0xFBFF. Additionally, the EEPROM addresses for application parameters are listed in Table 21.

The same EEPROM read and write instructions described in sections 4.7 and 4.10 are used to upload new firmware or update the customer configuration parameters.

IMPORTANT - The number of EEPROM erase/write cycles is limited to 1M.

4.1. EEPROM Mapping and Application Parameters

Table 20: EEPROM Mapping

EEPROM Addressed (Hex)	Description
0000-FBFF	Download firmware starting at address 0x0000 Note: Firmware size may be smaller. IMPORTANT - Do not write in the range; (end of firmware):0xFBFF
FC00-FFFF	Application parameters. See Table 21 for detail.

Table 21: EEPROM addresses for Application parameters

EEPROM @ (Hex)	Size (Hex)	Variable Name	Description
FC00 FC13	14	FwConfigPathB	Firmware Configuration Path B. See Table 22 for details.
FC14 FC27	14	FwConfigPathA	Firmware Configuration Path A Structure. See Table 22 for details.
FC28 FC8D	66	CAL1ParamPathB	Calibration Parameters for Path B. See Table 24 for details.
FC8E-FDF3		Reserved	Reserved (DO NOT CHANGE VALUES)
FCF4 FD59	66	CAL1ParamPathA	Calibration Parameters for Path A. See Table 24 for details.
FD5A-FDBF		Reserved	Reserved (DO NOT CHANGE VALUES)
FDC0 FDC2	3	DeviceConfig	Device Configuration affects both Channel A and B. See Table 23 for detail description.
FDC3-FEFD		Reserved	Reserved (DO NOT CHANGE VALUES)
FEFE FF1B	1D	AdvConfig	Advanced Device Configuration affects both channel A and B. See for Table 25 detail description.
FF1C-FFFE		Reserved	Reserved (DO NOT CHANGE VALUES)
FFFF	UINT8	Checksum	Checksum = XOR(FC00:FFFE). See section 7.2.

IMPORTANT

1. 16-bit values are Big-endian.
2. Address 0xFFFF checksum = XOR(FC00:FFFE)
If the checksum does not match, the firmware will issue an error 3
3. It is possible to also check the Application parameters EEPROM mapping with the SC2200GUI ACCP Config tab.

Group	Variable Name	Address	Value	Commands
Path B/FW Config	Linearizer Gain	0xFC12	3	
Path A/FW Config	MinFreqScan	0xFC14	3600	
Path A/FW Config	MaxFreqScan	0xFC16	3800	
Path A/FW Config	AdaptOnTime_10ms	0xFC18	0	0 = 250ms (Default). On time in 10mS increments for adapting pathA
Path A/FW Config	RFFB PMU Offset	0xFC1B	403	
Path A/FW Config	RFIN PMU Offset	0xFC1D	3613	
Path A/FW Config	Adaptation State	0xFC1F	0	
Path A/FW Config	Periodic PMU Disable	0xFC21	0	
Path A/FW Config	Correction Enable	0xFC22	0	
Path A/FW Config	Linearizer Gain	0xFC26	3	
Path B/CalFreq1	MaxPWRCALParam1_RFIN_MAX_PWR	0xFC28	-1937	
Path B/CalFreq1	MaxPWRCALParam2_RFFB_MAX_PWR	0xFC2A	-5317	
Path B/CalFreq1	MaxPWRCALParam3_PDET	0xFC2C	1	
Path B/CalFreq1	MaxPWRCALParam4	0xFC2D	1	
Path B/CalFreq1	MaxPWRCALParam5_IC_temp	0xFC2E	182	
Path B/CalFreq1	MaxPWRCALParam6_CorrVgaldx	0xFC30	5	
Path B/CalFreq1	MaxPWRCALParam7	0xFC31	15	
Path B/CalFreq1	MaxPWRCALParam8	0xFC32	126	
Path B/CalFreq1	MaxPWRCALParam9	0xFC33	129	
Path B/CalFreq1	MaxPWRCALParam10_Freq	0xFC34	3720	
Path B/CalFreq1	MaxPWRCALParam11	0xFC36	215	
Path B/CalFreq1	MaxPWRCALParam12	0xFC37	22	
Path B/CalFreq1	MaxPWRCALParam13	0xFC38	Edit	
Path B/CalFreq1	MaxPWRCALCoefficients	0xFC50	Edit	
Path B/CalFreq1	MaxPWRCALParam14	0xFC82	Edit	
Path B/CalFreq1	MaxPWRCALParam15	0xFC8D	217	
Path A/CalFreq1	MaxPWRCALParam1_RFIN_MAX_PWR	0xFCF4	-1826	
Path A/CalFreq1	MaxPWRCALParam2_RFFB_MAX_PWR	0xFCF6	-5322	
Path A/CalFreq1	MaxPWRCALParam3_PDET	0xFCF8	1	
Path A/CalFreq1	MaxPWRCALParam4	0xFCF9	1	
Path A/CalFreq1	MaxPWRCALParam5_IC_temp	0xFCFA	184	
Path A/CalFreq1	MaxPWRCALParam6_CorrVgaldx	0xFCFC	5	
Path A/CalFreq1	MaxPWRCALParam7	0xFCFD	16	
Path A/CalFreq1	MaxPWRCALParam8	0xFCFE	125	
Path A/CalFreq1	MaxPWRCALParam9	0xFCFF	127	
Path A/CalFreq1	MaxPWRCALParam10_Freq	0xFD00	3720	
Path A/CalFreq1	MaxPWRCALParam11	0xFD02	201	
Path A/CalFreq1	MaxPWRCALParam12	0xFD03	17	
Path A/CalFreq1	MaxPWRCALParam13	0xFD04	Edit	
Path A/CalFreq1	MaxPWRCALCoefficients	0xFD1C	Edit	
Path A/CalFreq1	MaxPWRCALParam14	0xFD4E	Edit	
Path A/CalFreq1	MaxPWRCALParam15	0xFD59	199	
Device/Config	RefFreqInkHz	0xFDC0	0	Ref clock Freq in kHz. 0 = 20MHz. 19200 kHz = 19.2MHz
Device/Config	ShutDownTime_10ms	0xFDC2	10	
Device/AdvConfig	Back Off Freeze Threshold	0xFEFE	0	
Device/AdvConfig	Corr V/GA Idx	0xFF01	0	Default = 5. Recommend value between 1 and 5.
Device/AdvConfig	PDET AGC Threshold	0xFF02	100	
Device/AdvConfig	Guard Band	0xFF0A	2	
Device/AdvConfig	ADC Sampling Rate	0xFF0D	0	0=100MHz, 1=25MHz
App	Checksum	0xFFFF	191	

Figure 4: EEPROM Mapping Capture from GUI ACCP Config tab

4.2. FwConfigPath Structure

Table 22: FwConfigPath Structure

Offset (Hex)	Size	Variable Name	Description
0	UINT16	MinFreqScan	Freq Range Minimum Bound: 16-bit value of 2*MHz value of 2xMinFrequencyScan (MHz)
2	UINT16	MaxFreqScan	Freq Range Maximum Bound: 16-bit value of 2*MHz value of 2xMaxFrequencyScan (MHz)
3	UINT8	AdaptOnTime_10ms	On time in 10mS increments for adapting corresponding path. When set to 0 in EEPROM (Default), FW use value of 25 in PRAM for 250ms. 5 means 50ms
4-A		Reserved	Do Not Change the Values
7	INT16	RFFB PMU Offset	RFFB PMU offset in dBN. dBm = 3.01*dBN/1024.
9	INT16	RFIN PMU Offset	RFIN PMU offset in dBN. dBm = 3.01*dBN/1024.
B	UINT8	Adaptation State	Adaptation State 0 = Running 1 = Frozen
C-D		Reserved	Do Not Change the Values
E	UINT8	Correction Enable	Correction Enable 0 = FW Control 1 = Disabled
F-11		Reserved	Do Not Change the Values
12	UINT8	Linearizer Gain	If set to a value other than 0 it sets the value as gain of linearizer between 3 and 6. =0 = default value of 5. See Table 26 for PA performance tuning details.
13	UINT	Reserved	Do Not Change the Values

IMPORTANT

- a. *Changing Linearizer Gain requires to recalibrate corresponding CAL1ParamPathA (or B) parameters*
- b. *RFIN and RFFB PMU offsets of path A are used for both path A and path B RFIN and RFFB PMU values.*

4.3. Device Configuration Structure

Table 23: Device Configuration Structure

Offset (Hex)	Size	Variable Name	Description
0	UINT16	RefFreqInkHz	Reference clock Frequency in kHz
2	UINT8	ShutDownTime_10ms	Amount of time in 10ms increments to turn off the system for power saving. Adaptation is frozen and coefficients are applied during Shut Down Time.

IMPORTANT - Changing these parameters affect both channel A and B, and requires recalibrating CAL1ParamPathA and CAL1ParamPathB parameters.

4.4. CAL Parameter Structure

Table 24: CAL Parameter Structure

Offset (Hex)	Size	Variable Name	Description
0	INT16	MaxPWRCALParam1 (RFIN MAX Power)	16-bit signed value of maximum Power Amplifier output power calibration parameter 1.
2	INT16	MaxPWRCALParam2 (RFFB MAX Power)	16-bit signed value of maximum Power Amplifier output power calibration parameter 2.
4	UINT8	MaxPWRCALParam3 (RFIN AGC=PDET)	8-bit unsigned value of maximum Power Amplifier output power calibration parameter 3. PDET Attenuation Index between 0 and 15.
5	UINT8	MaxPWRCALParam4	8-bit unsigned value of maximum Power Amplifier output power calibration parameter 4.
6	INT16	MaxPWRCALParam5 (IC_Temp)	16-bit signed value of maximum Power Amplifier output power calibration parameter 5.
8	UINT8	MaxPWRCALParam6 (Corr Vga Idx)	8-bit unsigned value of maximum Power Amplifier output power calibration parameter 6.
9	UINT8	MaxPWRCALParam7 (PDET DC offset DAC setting)	8-bit unsigned value of maximum Power Amplifier output power calibration parameter 7.
A	UINT8	MaxPWRCALParam8	8-bit unsigned value of maximum Power Amplifier output power calibration parameter 8.
B	UINT8	MaxPWRCALParam9	8-bit unsigned value of maximum Power Amplifier output power calibration parameter 9.
C	UINT16	MaxPWRCALParam10_Freq	Maximum Power Amplifier output power calibration parameter 10: Center frequency for calibration parameters in 2*MHz.
E	UINT8	MaxPWRCALParam11 (EDET DC offset DAC setting)	8-bit unsigned value of maximum Power Amplifier output power calibration parameter 11.
F	UINT8	MaxPWRCALParam12 (CORR multiplier DC offset DAC indices)	8-bit unsigned value of maximum Power Amplifier output power calibration parameter 12.
10	24xUINT8	MaxPWRCALParam13	24 8-bit unsigned value of maximum Power Amplifier output power calibration parameter 13.
28	50xINT8	MaxPWRCALCoefficients	50 8-bit signed values of maximum Power Amplifier output power calibration coefficients.
5A	INT16	MaxPWRCALParam14 (IQ imbalance calibration)	8-bit unsigned value of maximum Power Amplifier output power calibration parameter 14
5C-64		Reserved	Do Not Change the Values
65	UINT8	MaxPWRCALParam15	8-bit unsigned value of maximum Power Amplifier output power calibration parameter 15

4.5. Device Advanced Configuration Structure

Table 25: Advanced Device Configuration Structure

Offset (Hex)	Size	Variable Name	Description
0	UINT8	Back Off Freeze Threshold	If RFFB delta from MaxPWRCALParam2 power level is greater than Back Off Freeze Threshold, then adaptation stops. 0 = default = 15dB >1 = value in dB
1-2		Reserved	Do Not Change the Values
3	UINT8	CorrVGA_Idx	Coefficient Gain setting before RFSP up-conversion Default when set to 0 = 5 . Value between 1 and 5. See Table 26 for PA performance tuning details.
4	UINT8	PDET AGC Threshold	EDET and PDET AGC target threshold used to set TIA based off of signal PAR - Scaled up by 8x Default when set to 0 = 125 or 8*125 = 1000 in hardware). Value between 54 and 125. See Table 26 for PA performance tuning details.
5-9		Reserved	Do Not Change the Values
C	UINT8	Gard Band	Frequency band between the carrier edge (defined by the -24dBc signal bandwidth) and the IMD measurement region used for adaptation. 0 = 20% of the signal bandwidth is used (Default) Other value X =- X*0.5MHz is used (1 = 0.5MHz, 2 = 1MHz, 3 = 1.5 MHz, 4 = 2MHz, etc...) Signal bandwidth is defined with the -24dBc points. The actual in-band signal bandwidth might be wider and it is critical to carefully configure the guard band to avoid using in-band signal for the adaptation as this will negatively impact the performance.
D-E		Reserved	Do Not Change the Values
F	UINT8	ADC Sampling Rate Mode	If == 0 (default), set ADC Sample Rate to 100 MHz . Recommended for signal bandwidth ≥ 5MHz If == 1 set 25MHz (Recommend if signal bandwidth < 5MHz)
10-1D		Reserved	Do Not Change the Values

IMPORTANT - Changing these parameters affects both channel A and B, and makes it necessary to recalibrate CAL1ParamPathA and CAL1ParamPathB parameters.

Note: Please see Table 26 for PA performance tuning.

4.6. Performance Tuning Parameters

The following parameters might need to be adjusted for optimum performance

Table 26: Performance Tuning Parameters

Parameter	Default	Min	Max	Comment
FwConfigPathA.Linearizer_Gain	5	3	6	Gain for Correction Terms (after up-conversion) for path A. Increasing means more gain
FwConfigPathB.Linearizer_Gain	5	3	6	Gain for Correction Terms (after up-conversion) for path B. Increasing means more gain
AdvConfig.CorrVGA_Idx	5	1	5	Gain for Correction Terms (before up-conversion). Increasing means more gain
AdvConfig.PDET_AGC_Thresh	125	54	125	Sets the target value for the PDET AGC Block For more signal thru PDET path - increase value

Performance Tuning Recommendations

1. If ACLR is bouncing around a lot - this means the correction terms are probably too strong (relative to the thru path)
 - a. Option 1 - Reduce FwConfigPathA.Linearizer_Gain or/and FwConfigPathB.Linearizer_Gain
 - b. Option 2 - Reduce AdvConfig.CorrVGA_Idx (Affect both channels)
 - c. Option 3 - Reduce AdvConfig.PDET_AGC_Thresh (Affect both channels)
2. If ACLR correction seems slow or does not have enough "juice" increase correction strength (if the first 30 to 60 seconds of adaptation is "slow" or does not reach 80% of total correction), then Increase any of the parameters below
 - a. Option 1 - Increase FwConfigPathA.LinearizerGain
 - b. Option 2 - Increase AdvConfig.CorrVgaldx
 - c. Option 3 - Increase AdvConfig.PDET_AGC_Thresh
3. If performing Smooth Mode calibration at a slightly higher RFIN level improves performance, then, decrease AdvConfig.PDET_AGC_Thresh to achieve the same effect at the default RFIN level
4. If performing Smooth Mode calibration at a slightly lower RFIN level improves performance, then, increase AdvConfig.PDET_AGC_Thresh to achieve the same effect at the default RFIN level

IMPORTANT

- a. *It is recommended to do first adjust these parameters in Engineering Mode.*
- b. *Changing these parameters requires recalibrating CAL1ParamPathA and CAL1ParamPathB parameters.*
- c. *One set of parameters might offer the best performance under limited conditions, but not across all the system conditions*
- d. *Make sure to test and verify new settings over all the system conditions*
- e. *Make sure to do a Smooth Mode Calibration and evaluate performance over temperature, RFIN range and back-off.*

4.7. Meeting Spectral Emission Limits Very Close to Carrier

The guard band is the frequency band between the carrier edge (defined by the -24dBc signal bandwidth) and the IMD measurement region used for adaptation as illustrated in Figure 5.

If a particular Spectral Emission Mask (SEM) specification requires that distortion very close to the carrier be reduced more than it is with the default settings, then use of the guard band parameter may help to achieve the required specification.

The default setting is for the guard band region to be 20% of the carrier bandwidth.

For 20 MHz carriers, this means that the distortion in the 4MHz region on either side of the carrier is ignored. There will be some reduction of the distortion at 1MHz offset due to the linearizer acting on the IM3 distortion that it is considering, but potentially more reduction can be achieved at the 1MHz offset point by reducing the guard band region. It is not a good idea to use a value of 1 since carrier power may be inadvertently included in the distortion, but a value of 2 should be safe. Each unit represents approximately 0.5MHz.

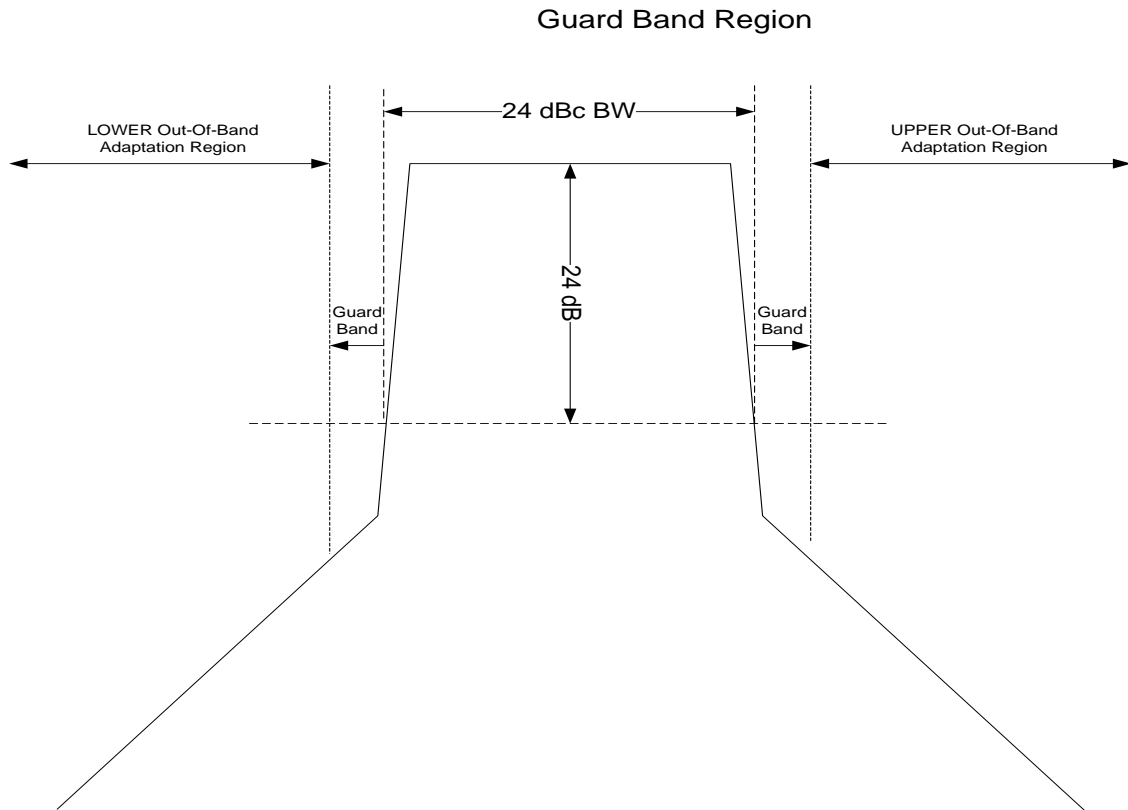

Figure 5: Guard Band Region

For a narrowband carrier such as 5MHz, changing the Guard Band parameter will likely not help,

4.8. EEPROM Write Instruction

The same procedure is used to write either to the firmware zone or the Application Parameters zone. It is recommended to write 128-bytes page at a time.

The following steps must be used for SPI write to EEPROM:

1. Operate the SPI Bus at up to 4MHz.
2. MS0 (pin 21) needs to be set HIGH (“1”). Host is now directly communicating with the embedded EEPROM.
3. UNLOCK EEPROM.
 - a. Issue a WREN (**0x06**) command to enable write operations to EEPROM



Host Sending

- b. Write zero to STATUS register to unlock: **01 00**

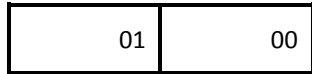

4. Make sure EEPROM is UNLOCKED by Reading STATUS register



Host EEPROM

STATUS register (XX) is 8 bit status register (bits 7 MSB to bit 0 LSB).

7	6	5	4	3	2	1	0
W/R	-	-	-	W/R	W/R	R	R
WPEN				BP1	BP0	WEL	WIP
W/R = Writable/Readable. R = Read-Only							

- The **Write-In-Process (WIP)** bit indicates whether the EEPROM is busy with a write operation. When set to a '1', a write is in progress, when set to a '0', no write is in progress. This bit is read-only.
- The **Block Protection (BP0 and BP1)** bits indicate if the EEPROM is locked or unlocked.
 - BP1 BP0 = 11 then EEPROM is locked
 - BP1 BP0 = 00 then EEPROM is unlocked

1. Issue a WREN (**0x06**) command to enable write operations to EEPROM



Host Sending Opcode

2. Issue a WRITE (0x02) command followed by the 16-bit address to be written followed by the contents to be written into that 128-byte page. If this is the last page, it is acceptable to write less than 128-bytes.
- Assert the SPI chip select, SSN which is active-low, and begin toggling the SCLK while driving the 24-bit Op-code (02 command + 16 bit EEPROM address) on the SDI pin.
 - The following N*8 clock edges clock in the N bytes of write data as shown below.
 - Following bit 0 of the last byte to be written, de-assert SSN

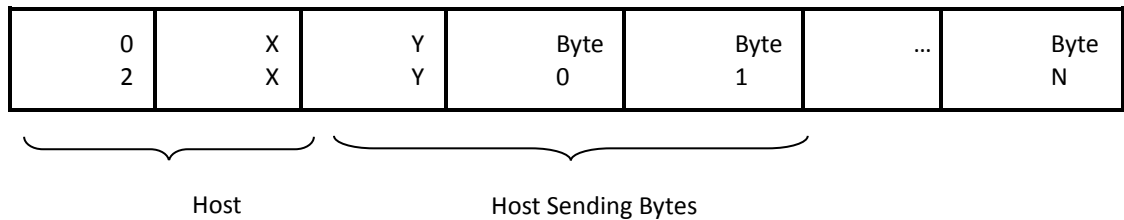

4.9. With XX YY 16-bit EEPROM address as described in

Table 20 and Table 21.

IMPORTANT - Up to 128-bytes can be written with one write instruction. Burst accesses should not cross 128-bytes page boundaries

3. Poll the STATUS register until the Write-In-Progress (WIP Bit 0) status changes from '1' (write in progress) to '0' (write completed).



Host EEPROM

4. Then repeat steps 1 to 3 until all bytes are written.

5. LOCK EEPROM to disable writes to the EEPROM.
 - a. Issue a WREN (**0x06**) command to enable write operations to EEPROM



Host

- b. Write "0C" to STATUS register to lock: **01 0C**

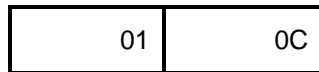

Host

6. Make sure EEPROM is LOCKED by Reading STATUS register

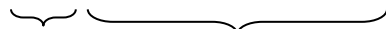
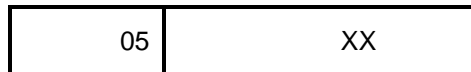

Host

EEPROM

XX is 8-bit status register (bits 7 MSB to bit 0 LSB).

- If bit 2-3=11 then EEPROM is locked
 - If bit 2-3=00 then EEPROM is unlocked
7. MS0 needs to be set back to LOW ("0") when done writing to EEPROM
 8. Reset using pin 23 (RESETN)

4.10. EEPROM Read Instruction

The same procedure is used to read either to the firmware zone or the Application Parameters zone.

The following steps must be used for SPI read to EEPROM:

1. Operate the SPI Bus at up to 4MHz.
2. MS0 needs to be set HIGH ("1").
3. Issue a READ (0x03) command followed by the 16-bit address to be read.
 - a. Assert the SPI chip select, SSN which is active low, and begin toggling the SCLK while driving the 24-bit Op-code (03 read command + 16 bit EEPROM address) on the SDI pin.
 - b. The following N*8 clock edges clock in the N bytes of write data
 - c. Following bit 0 of the last byte to be written, deassert SSN

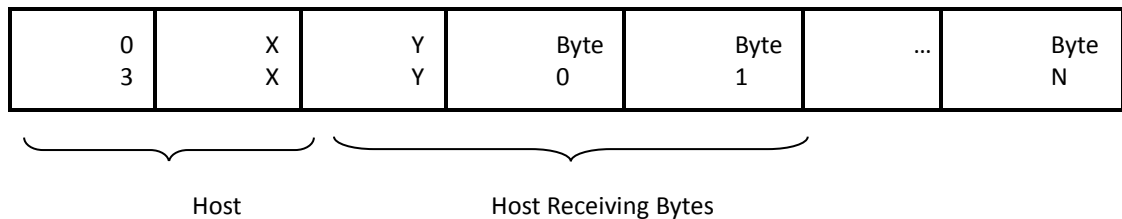

With XX YY 16-bit EEPROM address as described in

Table 20 and Table 21.

4. MS0 needs to be set back to LOW ("0") when done reading EEPROM

IMPORTANT - No restrictions on Read instructions for N. Must follow the setup and hold times as well as other timing requirements as described in the data sheet.

4.11. EEPROM Endurance

Table 27 shows the guaranteed number of EEPROM write/erase cycles across worst case supply voltage and temperature range unless otherwise specified.

Table 27: SC2200 EEPROM Endurance

PARAMETER	SYMBOL	CONDITIONS	MIN	TYP	MAX	UNITS
EEPROM Write/Erase Cycles			1M			—

5. PRAM Application Parameters

All the EEPROM Application parameters defined in Table 21 are loaded to PRAM at boot-up after power on or after Reset. Section 2.5 described how to read back all the application parameters from PRAM after boot-up and how to dynamically change some of these parameters by writing to PRAM.

IMPORTANT - The Application parameters checksum is only checked when loaded from EEPROM to PRAM. So when changing parameters in PRAM, it is not required to update the checksum parameters.

5.1. To Enable/Disable Correction with PRAM Parameter

To disable correction, the following command is written to the Message Interface Buffer:

247 5 252 14 1 1 0 0 0 0 0 0 0 0 0 0

CS = 247

OP = 5 to write to PRAM

Addr MSB = 252, Addr LSB = 14. Address = $252 \times 256 + 14 = 0xFC0E$.

SZ = 1-bytes to write.

B0 = 1

Response read from the Message Interface Buffer:

1 0 0 0 0 0 0 0 0 0 0 0 0 0 0 1

CS = 1, ACK = 1 for successful write

To enable correction, the following command is written to the Message Interface Buffer:

246 5 252 14 1 0 0 0 0 0 0 0 0 0 0

CS = 246

OP = 5 to write to PRAM

Addr MSB = 252, Addr LSB = 14. Address = $252 \times 256 + 14 = 0xFC0E$.

SZ = 1-bytes to write.

B0 = 0

Response read from the Message Interface Buffer:

1 0 0 0 0 0 0 0 0 0 0 0 0 0 0 1

CS = 1, ACK = 1 for successful write

5.2. To Freeze/UnFreeze Adaptation with PRAM Parameter

To freeze adaptation, the following command is written to the Message Interface Buffer:

242 5 252 11 1 1 0 0 0 0 0 0 0 0

CS = 242

OP = 5 to write to PRAM

Addr MSB = 252, Addr LSB = 11. Address = $252 * 256 + 11 = 0xFC0B$.

SZ = 1-bytes to write.

B0 = 1

Response read from the Message Interface Buffer:

1 0 0 0 0 0 0 0 0 0 0 0 0 0 0 1

CS = 1, ACK = 1 for successful write

To unfreeze adaptation, the following command is written to the Message Interface Buffer:

243 5 252 11 1 0 0 0 0 0 0 0 0 0

CS = 243

OP = 5 to Write to PRAM

Addr MSB = 252, Addr LSB = 11. Address = $252 * 256 + 11 = 0xFC0B$.

SZ = 1-bytes to write.

B0 = 0

Response read from the Message Interface Buffer:

1 0 0 0 0 0 0 0 0 0 0 0 0 0 0 1

CS = 1, ACK = 1 for successful write

5.3. To Read back Adaptation State and Correction Enable from PRAM

To read back the adaptation state and correction enable status, the following command is written to the Message Interface Buffer: **247 4 252 11 4 0 0 0 0 0 0 0 0 0 0**

CS = 247, OP = 4 to read from PRAM

Addr MSB = 252, Addr LSB = 11. Address = $252 * 256 + 11 = 0xFC0B$.

SZ = 4-bytes to read

Response read from the Message Interface Buffer:

1 1 0 0 1 0 0 0 0 0 0 0 0 0 0 1

CS = 1

B0 = 1 = Adaptation State = Frozen

B1= B2 = 0

B3 = 1 = Correction Enable = Disabled

ACK = 1 = Successful read.

If only the Correction Enable status is read, then the following command is written to the Message Interface Buffer: **247 4 252 14 1 0 0 0 0 0 0 0 0 0 0**

CS=247, OP = 4 to read from PRAM

Addr MSB = 252, Addr LSB = 14. Address = $252*256 + 14 = 0xFC0E$.

SZ = 1-bytes to read

Then the response read from the Message Interface Buffer is:

243 1 252 14 1 0 0 0 0 0 0 0 0 0 1

CS = 243

B0 = 1 = Correction Enable = Disabled

Please note that since only-byte is read, B1, B2 and B3 are not written from SC2200 and still contain part of the host command written to the message buffer.

6. 16-byte Host Message Interface Examples

6.1. SC2200_Clear_Calibration

To Clear Calibration for Path A (See section 2.7 for command detail and section

[errorFlag] = SC2200_Clear_Calibration(d, 0)

Command Buffer sent to SC2200: **7 7 0 0 0 0 0 0 0 0 0 0 0 0 0 0**

(Try 0) Buffer read from SC2200: 0 0 0 0 0 0 0 0 0 0 0 0 0 0 0 0 **255**

...

(Try 33) Buffer read from SC2200: 0 0 0 0 0 0 0 0 0 0 0 0 0 0 0 0 **255**

(Try 34) Buffer read from SC2200: **1 0 0 0 0 0 0 0 0 0 0 0 0 0 0 0 1**

errorFlag = 0

IMPORTANT – ACK = 1, this means the read was successful and data is valid. It is critical to wait for ACK=1 before reading the response. 255 means that the response is not ready yet.

To Clear Calibration for Path B

[errorFlag] = SC2200_Clear_Calibration(d, 1)

Command buffer sent to SC2200: **6 7 1 0 0 0 0 0 0 0 0 0 0 0 0 0**

(Try 0) Buffer read from SC2200: 0 0 0 0 0 0 0 0 0 0 0 0 0 0 0 0 **255**

(Try 1) Buffer read from SC2200: 0 0 0 0 0 0 0 0 0 0 0 0 0 0 0 0 **255**

...

(Try 33) Buffer read from SC2200: 0 0 0 0 0 0 0 0 0 0 0 0 0 0 0 0 **255**

(Try 34) Buffer read from SC2200: **1 0 0 0 0 0 0 0 0 0 0 0 0 0 0 0 1**

errorFlag = 0

6.2. SC2200_Set_Calibration

To Set Calibration for Path A:

[errorFlag] = SC2200_Set_Calibration(d, 0)

Command buffer sent to SC2200: **8 8 0 0 0 0 0 0 0 0 0 0 0 0 0 0**

(Try 0) Buffer read from SC2200: 0 0 0 0 0 0 0 0 0 0 0 0 0 0 0 0 **255**

(Try 1) Buffer read from SC2200: 0 0 0 0 0 0 0 0 0 0 0 0 0 0 0 0 **255**

...

(Try 33) Buffer read from SC2200: 0 0 0 0 0 0 0 0 0 0 0 0 0 0 0 0 **255**

(Try 34) Buffer read from SC2200: **1 0 0 0 0 0 0 0 0 0 0 0 0 0 0 0 1**

errorFlag = 0

IMPORTANT – ACK = 1, this means the read was successful and data is valid. It is critical to wait for ACK = 1 before reading the response. 255 means that the response is not ready yet.

To Set Calibration for Path B:

[errorFlag] = SC2200_Set_Calibration(d, 1)

Command buffer sent to SC2200: **9 8 1 0 0 0 0 0 0 0 0 0 0 0 0 0**

(Try 0) Buffer read from SC2200: 0 0 0 0 0 0 0 0 0 0 0 0 0 0 0 0 **255**

(Try 1) Buffer read from SC2200: 0 0 0 0 0 0 0 0 0 0 0 0 0 0 0 0 **255**

...

(Try 33) Buffer read from SC2200: 0 0 0 0 0 0 0 0 0 0 0 0 0 0 0 0 **255**

(Try 34) Buffer read from SC2200: **1 0 0 0 0 0 0 0 0 0 0 0 0 0 0 0 1**

errorFlag = 0

6.3. Reading Device Information from Scratch

When using the Matlab routine described in section 7.4 to read the device info structure (defined in Table 11), the following commands are exchanged:

```
Command buffer sent to SC2200: 71 0 64 0 7 0 0 0 0 0 0 0 0 0 0 0
```

```
(Try 0) Buffer read from SC2200: 159 83 80 9 4 0 8 152 0 0 0 0 0 0 0 1
```

```
Device_Information =
```

```
    FirmwareProductVersion: 2200 = 8*256+152
```

```
        HW_Version: 83
```

```
        FW_Version: '50' (0x50= 80 in decimal)
```

```
        FW_Build: [9 4]
```

6.4. Reading Path A/B FW Status from Scratch

See SC2200_Get_Paths_Status Matlab example code in section 7.6.

```
% With No RF signal
```

```
[errFlag, FwStatusPathA] = d.msg.ReadXdata(hex2dec('4000')+58, 0, 9)
```

```
Command buffer sent to SC2200: 115 0 64 58 9 0 0 0 0 0 0 0 0 0 0 0
```

```
(Try 0) Buffer read from SC2200: 79 5 0 1 21 24 204 0 239 100 0 0 0 0 0 1
```

```
FwStatusPathA = [5 0 1 21 24 204 0 239 100]
```

```
PathA.FwStatus_State = 5 = 'FROZEN'
```

```
PathA.FwStatus_ErrorIndex = 0 = No Errors
```

```
PathA.FwStatus_InfoIndex= 1
```

```
PathA.FwStatus_CenterFrequency = (21*256+24)/2 = 2700MHz
```

```
PathA.FwStatus_SignalBW = (204/2) = 102 MHz (Means no RF signal is detected)
```

```
PathA.FwStatus_CostFunction= Convert16B_signed_SC2200(239*256+100)=-4221
```

```
% With RF signal, Path A with 20MHz LTE
```

```
[errFlag, FwStatusPathA] = d.msg.ReadXdata(hex2dec('4000')+58, 0, 9)
```

```
Command buffer sent to SC2200: 115 0 64 58 9 0 0 0 0 0 0 0 0 0 0 0
```

```
(Try 0) Buffer read from SC2200: 3 4 0 0 17 248 39 0 182 126 0 0 0 0 0 1
```

```
FwStatusPathA = [4 0 0 17 248 39 0 182 126]
```

```
PathA.FwStatus_State = 4 = 'TRACK'
```

```
PathA.FwStatus_ErrorIndex = 0 = No Error
```

```
PathA.FwStatus_InfoIndex= 0 = No Infor
```

```
PathA.FwStatus_CenterFrequency = (17*256+248)/2 = 2300MHz
```

```
PathA.FwStatus_SignalBW = (39/2) = 19.5 MHz
```

```
PathA.FwStatus_CostFunction= Convert16B_signed_SC2200(182*256+126)= -18818
```

```
% With RF signal, Path B with 20MHz LTE
```

```
[errFlag, FwStatusPathB] = d.msg.ReadXdata(hex2dec('4000')+72, 0, 9)
```

```
Command buffer sent to SC2200: 1 0 64 72 9 0 0 0 0 0 0 0 0 0 0 0
```

```
(Try 0) Buffer read from SC2200: 220 4 0 0 17 248 39 0 207 216 0 0 0 0 0 1
```

```
FwStatusPathB = [4 0 0 17 248 39 0 207 216]
```

```
PathB.FwStatus_State = 4 = 'TRACK'
```

```
PathB.FwStatus_ErrorIndex = 0 = No Error
```

```
PathB.FwStatus_InfoIndex= 0 = No Infor
```

```
PathB.FwStatus_CenterFrequency = (17 * 256 + 248)/2 = 2300MHz
```

```
PathB.FwStatus_SignalBW = (39/2) = 19.5MHz
```

```
PathB.FwStatus_CostFunction = Convert16B_signed_SC2200(207*256+216) = -12328
```

6.5. Reading Device FW Debug Information from Scratch

To read the first element of the Error Stack (Index=0)

```
[errFlag, ErrorStack] = d.msg.ReadXdata(hex2dec('407A'), 0, 2);
```

```
Command buffer sent to SC2200: 56 0 64 122 2 0 0 0 0 0 0 0 0 0 0 0
```

```
(Try 0) Buffer read from SC2200: 1 0 0 0 0 0 0 0 0 0 0 0 0 0 0 1
```

```
Device_FW_Debug.ErrorStack_error(0) = 0 %No error
```

```
Device_FW_Debug.ErrorStack_path(0) = 0 % Path A by default if No error
```

To read the first element of the Info Stack (Index=0)

```
[errFlag, InfoStack] = d.msg.ReadXdata(hex2dec('4098'), 0, 2);
```

```
Command buffer sent to SC2200: 218 0 64 152 2 0 0 0 0 0 0 0 0 0 0 0
```

```
(Try 0) Buffer read from SC2200: 15 14 0 0 0 0 0 0 0 0 0 0 0 0 0 1
```

```
Device_FW_Debug.InfoStack_info(0) = 14 % Path A was calibrated with no RF signal on RFFB
```

```
Device_FW_Debug.ErrorStack_path(0) = 0 % Path A
```

To read the second element of the Info Stack (Index=1)

```
[errFlag, InfoStack] = d.msg.ReadXdata(1*3+hex2dec('4098'), 0, 2);
```

```
Command buffer sent to SC2200: 217 0 64 155 2 0 0 0 0 0 0 0 0 0 0 0
```

```
(Try 0) Buffer read from SC2200: 17 16 0 0 0 0 0 0 0 0 0 0 0 0 0 1
```

```
Device_FW_Debug.InfoStack_info(0) = 16 % Path A was calibrated with no RF signal on RFIN
```

```
Device_FW_Debug.ErrorStack_path(0) = 0 % Path A
```

To read the third element of the Info Stack (Index=2)

```
[errFlag, InfoStack] = d.msg.ReadXdata(2*3+hex2dec('4098'), 0, 2);
```

```
Command buffer sent to SC2200: 220 0 64 158 2 0 0 0 0 0 0 0 0 0 0 0
```

```
(Try 0) Buffer read from SC2200: 14 14 1 0 0 0 0 0 0 0 0 0 0 0 0 1
```

```
Device_FW_Debug.InfoStack_info(0) = 14 % Path B was calibrated with no RF signal on RFFB
```

```
Device_FW_Debug.ErrorStack_path(0) = 1 % Path B
```

6.6. Clear Info Stack

To clear Info Stack, write to Global Scratch parameter at address 0x330

See section 2.4 for exact command description to write to Scratch

```
errFlag = d.msg.WriteXdata(hex2dec('4330'),0,1); %Write 1 to Global Scratch address 0x330
```

```
Command buffer sent to SC2200: 114 1 67 48 1 0 1 0 0 0 0 0 0 0 0 0
```

```
(Try 0) Buffer read from SC2200: 1 0 0 0 0 0 0 0 0 0 0 0 0 0 0 1
```

```
errFlag = 0 %Clear successful.
```

6.7. Read RFIN and RFFB AGC Values

Using the Matlab example code described in section 7.5 to read the AGC values.

```
[errFlag, RfStatusPathA] = d.msg.ReadXdata(hex2dec('4000')+86, 0, 5);  
Command buffer sent to SC2200: 19 0 64 86 5 0 0 0 0 0 0 0 0 0 0  
(Try 0) Buffer read from SC2200: 11 17 26 0 0 1 0 0 0 0 0 0 0 0 0 1  
PathA.RfStatus_RFFB_AGC= RfStatusPathA(2) = 26  
PathA.RfStatus_RFIN_AGC= RfStatusPathA(4)*256+RfStatusPathA(5) = 0*256+1=1
```

Similarly on Path B

```
[errFlag, RfStatusPathB] = d.msg.ReadXdata(hex2dec('4000')+104, 0, 5);  
Command buffer sent to SC2200: 45 0 64 104 5 0 0 0 0 0 0 0 0 0 0  
(Try 0) Buffer read from SC2200: 6 17 23 0 0 1 0 0 0 0 0 0 0 0 0 1  
PathB.RfStatus_RFFB_AGC= RfStatusPathB(2) = 23  
PathB.RfStatus_RFIN_AGC= RfStatusPathB(4)*256+RfStatusPathB(5) = 0*256+1= 1
```

6.8. Read RFIN and RFFB PMU Values

Using the Matlab example code described in section 7.5 to read the PMU values.

```
[errFlag, PMU_pathA] = d.msg.ReadXdata(hex2dec('4000')+196, 0, 14);  
Command buffer sent to SC2200: 138 0 64 196 14 0 0 0 0 0 0 0 0 0 0  
(Try 0) Buffer read from SC2200: 15 234 167 0 0 0 0 235 61 0 0 0 0 255 106 1
```

IMPORTANT – ACK = 1, this means the read was successful and data is valid. It is critical to wait for ACK = 1 before reading the response.

```
PathA.PMU_RFFB =  
round(30.1*Convert16B_signed_SC2200(double(PMU_pathA(1))*256+double(PMU_pathA(2)))/  
1024)/10  
= PathA.PMU_RFFB =  
round(30.1*Convert16B_signed_SC2200(double(234)*256+double(167))/1024)/10 = -16.2dBm  
PathA.PMU_RFIN =  
round(30.1*Convert16B_signed_SC2200(double(PMU_pathA(7))*256+double(PMU_pathA(8)))/  
1024)/10  
= PathA.PMU_RFIN =  
round(30.1*Convert16B_signed_SC2200(double(235)*256+double(61))/1024)/10 = -15.6dBm
```

Similarly on Path B

```
[errFlag, PMU_pathB] = d.msg.ReadXdata(hex2dec('4000')+182, 0, 14);  
Command buffer sent to SC2200: 248 0 64 182 14 0 0 0 0 0 0 0 0 0 0  
(Try 0) Buffer read from SC2200: 1 235 239 0 0 0 0 235 198 0 0 0 0 0 41 1  
PathB.PMU_RFFB =  
round(30.1*Convert16B_signed_SC2200(double(PMU_pathB(1))*256+double(PMU_pathB(2)))/  
1024)/10  
= round(30.1*Convert16B_signed_SC2200(double(235)*256+double(239))/1024)/10 = -  
15.1dBm  
PathB.PMU_RFIN =  
round(30.1*Convert16B_signed_SC2200(double(PMU_pathB(7))*256+double(PMU_pathB(8)))/  
1024)/10  
= round(30.1*Convert16B_signed_SC2200(double(235)*256+double(198))/1024)/10 = -  
15.2dBm
```

7. Matlab Example Codes

7.1. SC2200_Read_ApplicationParameters (From EEPROM)

```
function [Application_Parameters]=
SC2200_Read_customerConfigParameters(d)

cfg = d.EEPROM.EEPROM.Read(hex2dec('FC00'),1024)
%===== Path A =====
% FW Configuration
Application_Parameters.PathA_FwConfig_minFreq =
(double(cfg(21))*256+double(cfg(22)))/2;
Application_Parameters.PathA_FwConfig_maxFreq =
(double(cfg(23))*256+double(cfg(24)))/2;
Application_Parameters.PathA_FwConfig_AdaptOnTime_10ms =
10*cfg(25);%x10 for ms
Application_Parameters.PathA_FwConfig_AdaptationState = cfg(32);
Application_Parameters.PathA_FwConfig_CorrectionEnable = cfg(35);
Application_Parameters.PathA_FwConfig_LinearizerGain = cfg(39);
% Calibration Point 1 Calibration
Application_Parameters.PathA_CAL1Param1 =
round(10*3.01*Convert16B_signed_SC2200(double(cfg(245))*256+double(cfg(
246)))/1024)/10;
Application_Parameters.PathA_CAL1Param2 =
round(10*3.01*Convert16B_signed_SC2200(double(cfg(247))*256+double(cfg(
248)))/1024)/10;
Application_Parameters.PathA_PDET_CAL1Param3 = cfg(249);
Application_Parameters.PathB_CAL1Param4 = cfg(250);
Application_Parameters.PathA_CAL1Param5 =
Convert16B_signed_SC2200(double(cfg(251))*256+double(cfg(252)));
Application_Parameters.PathA_CAL1Param6 = cfg(253);
Application_Parameters.PathA_CAL1Param7 = cfg(254);
Application_Parameters.PathA_CAL1Param8 = cfg(255);
Application_Parameters.PathA_CAL1Param9 = cfg(256);
Application_Parameters.PathA_Freq_CAL1Param10 =
(double(cfg(257))*256+double(cfg(258)))/2;
Application_Parameters.PathA_CAL1Param11 = cfg(259);
Application_Parameters.PathA_CAL1Param12 = cfg(260);
Application_Parameters.PathA_CAL1Param13 = cfg(261:284);
Application_Parameters.PathA_CAL1Coeffs = cfg(285:334);
Application_Parameters.PathA_CAL1Param14 =
[Convert16B_signed_SC2200(double(cfg(335))*256+double(cfg(336)))
Convert16B_signed_SC2200(double(cfg(337))*256+double(cfg(338)))]];
Application_Parameters.PathA_MaxPWRCALParam15 = cfg(346);
% Miscellaneous Configuration Parameters for Path A
Application_Parameters.PathA_MiscConfig_RFAUX_Offset = cfg(703);

%===== Path B =====
% FW Configuration
Application_Parameters.PathB_FwConfig_minFreq =
(double(cfg(1))*256+double(cfg(2)))/2;
```

```

Application_Parameters.PathB_FwConfig_maxFreq =
(double(cfg(3))*256+double(cfg(4)))/2;
Application_Parameters.PathB_FWConfig_AdaptOnTime_10ms =
10*cfg(5);%x10 for ms
Application_Parameters.PathB_FwConfig_AdaptationState = cfg(12);
Application_Parameters.PathB_FwConfig_CorrectionEnable = cfg(15);
Application_Parameters.PathB_FwConfig_LinearizerGain = cfg(18);
% Calibration Point 1 Calibration
Application_Parameters.PathB_CAL1Param1 =
round(10*3.01*Convert16B_signed_SC2200(double(cfg(41))*256+double(cfg(
42)))/1024)/10;
Application_Parameters.PathB_CAL1Param2 =
round(10*3.01*Convert16B_signed_SC2200(double(cfg(43))*256+double(cfg(
44)))/1024)/10;
Application_Parameters.PathB_PDET_CAL1Param3 = cfg(45);
Application_Parameters.PathB_CAL1Param4 = cfg(46);
Application_Parameters.PathB_CAL1Param5 =
Convert16B_signed_SC2200(double(cfg(47))*256+double(cfg(48)));
Application_Parameters.PathB_CAL1Param6 = cfg(49);
Application_Parameters.PathB_CAL1Param7 = cfg(50);
Application_Parameters.PathB_CAL1Param8 = cfg(51);
Application_Parameters.PathB_CAL1Param9 = cfg(52);
Application_Parameters.PathB_Freq_CAL1Param10 =
(double(cfg(53))*256+double(cfg(54)))/2;
Application_Parameters.PathB_CAL1Param11 = cfg(55);
Application_Parameters.PathB_CAL1Param12 = cfg(56);
Application_Parameters.PathB_CAL1Param13 = cfg(57:80);
Application_Parameters.PathB_CAL1Coeffs = cfg(81:130);
Application_Parameters.PathB_CAL1Param14 =
[Convert16B_signed_SC2200(double(cfg(130))*256+double(cfg(131)))
Convert16B_signed_SC2200(double(cfg(132))*256+double(cfg(133)))]
Application_Parameters.PathB_MaxPWRCALParam15 = cfg(142);
% Miscellaneous Configuration Parameters for Path B
Application_Parameters.PathB_MiscConfig_RFAUX_Offset = cfg(735);
%==== Device Configuration =====
Application_Parameters.DeviceConfig_RefFreqInkHz =
double(cfg(449))*256+double(cfg(450));
Application_Parameters.DeviceConfig_PowerDownTime_10ms = 10*cfg(450);
%==== Device Advanced Configuration =====
Application_Parameters.DeviceAdvConfig_BackOffFreezeThreshold =
cfg(767);
Application_Parameters.DeviceAdvConfig_CorrVGAIdx = cfg(770);
Application_Parameters.DeviceAdvConfig_PdetAgcThreshold = cfg(771);
Application_Parameters.DeviceAdvConfig_PdetDcOffsetTarget = cfg(772);
Application_Parameters.DeviceAdvConfig_EdetDcosTarget = cfg(773);
if (cfg(778)==0)
    Application_Parameters.AdvConfig_GuardBand = '0=20%';
else
    Application_Parameters.AdvConfig_GuardBand = '=value*0.5MHz';
end
if (cfg(781)==0)
    Application_Parameters.AdvConfig_ADC_SamplingRate = '0=100MHz';

```

```
elseif (cfg(781)==1)
Application_Parameters.AdvConfig_ADC_SamplingRate = '1=25MHz';
else
    Application_Parameters.AdvConfig_ADC_SamplingRate = 'Wrong setting';
end

%Computing Checksum to verify
checksum = double(0);
for i=1:1023
    checksum=bitxor(double(checksum),double(cfg(i)));
end
if (checksum==cfg(1,1024))
    Application_Parameters.checksum='Valid';
else
    Application_Parameters.checksum='Invalid';
end
```

7.2. SC2200_SetFrequencyScan (In EEPROM)

```
function [customerConfigParameters]=SC2200_SetFrequencyScan(d)
% Parameters:
% d (in): RFPAL object
customerConfigParameters = d.EEPROM.EEPROM.Read(hex2dec('FC00'),1024);
FwConfigPathB_minFreq=2600; % Set to 2600 MHz
FwConfigPathB_maxFreq=2700; % Set to 2700 MHz
FwConfigPathA_minFreq=2600; % Set to 2600 MHz
FwConfigPathA_maxFreq=2700; % Set to 2700 MHz

customerConfigParameters(1)=
floor(2*FwConfigPathB_minFreq/256); %2xMin Freq
Scan MSB
customerConfigParameters(2)= 2*FwConfigPathB_minFreq-256*floor
(2*FwConfigPathB_minFreq/256); %2xMin Freq Scan LSB
customerConfigParameters(3)= floor
(2*FwConfigPathB_maxFreq/256); %2xMax Freq Scan
MSB
customerConfigParameters(4)= 2*FwConfigPathB_maxFreq-256*floor
(2*FwConfigPathB_maxFreq/256); %2xMax Freq Scan LSB
customerConfigParameters(21)= floor
(2*FwConfigPathA_minFreq/256); %2xMin Freq Scan
MSB
customerConfigParameters(22)= 2*FwConfigPathA_minFreq-256*floor
(2*FwConfigPathA_minFreq/256); %2xMin Freq Scan LSB
customerConfigParameters(23)= floor
(2*FwConfigPathA_maxFreq/256); %2xMax Freq Scan
MSB
customerConfigParameters(24)= 2*FwConfigPathA_maxFreq-256*floor
(2*FwConfigPathA_maxFreq/256); %2xMax Freq Scan LSB
%Computing New Checksum
checksum = uint8(0);
for i=1:1023
    checksum = bitxor(uint8 (checksum), uint8
(customerConfigParameters(i)));
end
customerConfigParameters(1024) = checksum;

d.EEPROM.EEPROM.Unlock;
d.EEPROM.EEPROM.Write(hex2dec('FC00'),customerConfigParameters(1:64))
d.EEPROM.EEPROM.Write(hex2dec('FC40'),customerConfigParameters(65:128))
d.EEPROM.EEPROM.Write(hex2dec('FC80'),customerConfigParameters(129:192
));
d.EEPROM.EEPROM.Write(hex2dec('FCC0'),customerConfigParameters(193:256
));
d.EEPROM.EEPROM.Write(hex2dec('FD00'),customerConfigParameters(257:320
));
d.EEPROM.EEPROM.Write(hex2dec('FD40'),customerConfigParameters(321:384
));
d.EEPROM.EEPROM.Write(hex2dec('FD80'),customerConfigParameters(385:448
));
```

```
d.EEPROM.EEPROM.Write(hex2dec('FDC0'),customerConfigParameters(449:512
));
d.EEPROM.EEPROM.Write(hex2dec('FE00'),customerConfigParameters(513:576
));
d.EEPROM.EEPROM.Write(hex2dec('FE40'),customerConfigParameters(577:640
));
d.EEPROM.EEPROM.Write(hex2dec('FE80'),customerConfigParameters(641:704
));
d.EEPROM.EEPROM.Write(hex2dec('FEC0'),customerConfigParameters(705:768
));
d.EEPROM.EEPROM.Write(hex2dec('FF00'),customerConfigParameters(769:832
));
d.EEPROM.EEPROM.Write(hex2dec('FF40'),customerConfigParameters(833:896
));
d.EEPROM.EEPROM.Write(hex2dec('FF80'),customerConfigParameters(897:960
));
d.EEPROM.EEPROM.Write(hex2dec('FFC0'),customerConfigParameters(961:102
4));
d.EEPROM.EEPROM.Lock;
d.HardReset
```

7.3. SC2200_SetClockRef (In EEPROM)

```
function [customerConfigParameters]=SC2200_SetClockRef(d, ClockRef)
% Parameters:
% d (in): RFPAL object
% ClockRef (in: Reference clock frequency in kHz
customerConfigParameters = d.EEPROM.EEPROM.Read(hex2dec('FC00'),1024);
customerConfigParameters(449)=
floor(ClockRef/256); %2xMin Freq Scan MSB
customerConfigParameters(450)= ClockRef-
256*floor(ClockRef/256); %2xMin Freq Scan LSB
%Computing New Checksum
checksum = uint8 (0);
for i=1:1023
checksum = bitxor(uint8 (checksum), uint8
(customerConfigParameters(i)));
end
%Compute the New Checksum: Modulo256 of all bytes added from FC00 to
FFFE
customerConfigParameters(1024) = checksum;
d.EEPROM.EEPROM.Unlock;
d.EEPROM.EEPROM.Write(hex2dec('FDC0'),customerConfigParameters(449:512
));
d.EEPROM.EEPROM.Write(hex2dec('FFC0'),customerConfigParameters(961:102
4));
d.EEPROM.EEPROM.Lock;
d.HardReset %Hardware or SoftReset
```

7.4. SC2200_Get_Device_Information (From Scratch)

```
function [Device_Information] = SC2200_Get_Device_Information(d)
% Device Information
% Command buffer sent to SC2200: 71 0 64 0 7 0 0 0 0 0 0 0 0 0 0 0
% (Try 0) Buffer read from SC2200: 159 83 80 9 4 0 8 152 0 0 0 0 0 0 0
1
% Device_Information =
% FirmwareProductVersion: 2200
% HW_Version: 83
% FW_Version: '50'
% FW_Build: [9 4]
[errFlag, DeviceInfo] = d.msg.ReadXdata(hex2dec('4000'), 0, 7)

Device_Information.FirmwareProductVersion =
double(DeviceInfo(6))*256+double(DeviceInfo(7));

Device_Information.HW_Version = DeviceInfo(1); %83
Device_Information.FW_Version = dec2hex(DeviceInfo(2),2); %80=0x50
Device_Information.FW_Build = [DeviceInfo(3) DeviceInfo(4)]; %[9 4]

End
```

7.5. SC2200_Get_Device_FW_Status

```
function [Device_FW_Debug] = SC2200_Get_Device_FW_Debug(d)
% FW Debug Error and Information Stacks
for i=0:9
    % FW Debug Error Stack
    [errFlag, ErrorStack] = d.msg.ReadXdata(i*3+hex2dec('407A'), 0, 2);
    Device_FW_Debug.ErrorStack_error(i+1) = ErrorStack(1);
    Device_FW_Debug.ErrorStack_path(i+1) = ErrorStack(2);
    % FW Debug Information Stack
    [errFlag, InfoStack] = d.msg.ReadXdata(i*3+hex2dec('4098'), 0, 2);
    Device_FW_Debug.InfoStack_Info(i+1) = InfoStack(1);
    Device_FW_Debug.InfoStack_Channel(i+1) = InfoStack(2);
end
end
```

7.6. SC2200_Get_Paths_Status (From Scratch and PRAM)

```
function [PathA PathB] = SC2200_Get_Paths_Status(d)
STATUS_VCO_CAL=1;
STATUS_PDET_AGC=2;
STATUS_PMU=3;
STATUS_TRACK=4;
STATUS_FROZEN=5;
STATUS_FREQ_SCAN=6;
STATUS_SHUTDOWN=7;
%=====
% Path A Status
%=====
% Path A FwStatus Structure from Scratch
[errFlag, FwStatusPathA] = d.msg.ReadXdata(hex2dec('4000')+58, 0, 14)
stateA= FwStatusPathA(1)
if (stateA == STATUS_VCO_CAL)
    PathA.FwStatus_State='VCO_CAL';
elseif (stateA== STATUS_PDET_AGC)
    PathA.FwStatus_State='PDET_AGC';
elseif (stateA == STATUS_PMU)
    PathA.FwStatus_State='PMU';
elseif (stateA== STATUS_TRACK)
    PathA.FwStatus_State='TRACK';
elseif (stateA== STATUS_FROZEN)
    PathA.FwStatus_State='FROZEN';
elseif (stateA== STATUS_FREQ_SCAN)
    PathA.FwStatus_State='FREQ_SCAN';
elseif (stateA == STATUS_SHUTDOWN)
    PathA.FwStatus_State='SHUTDOWN';
else
    PathA.FwStatus_State='No Valid State';
end
PathA.FwStatus_ErrorIndex = FwStatusPathA(2);
PathA.FwStatus_InfoIndex = FwStatusPathA(3);
PathA.FwStatus_CenterFrequency=
(double(FwStatusPathA(4))*256+double(FwStatusPathA(5)))/2;
PathA.FwStatus_SignalBW = FwStatusPathA(6)/2;
PathA.FwStatus_CostFunction
Convert16B_signed_SC2200(double(FwStatusPathA(8))*256+double(FwStatusP
athA(9)));
% Path A RfStatus Structure from Scratch
[errFlag, RfStatusPathA] = d.msg.ReadXdata(hex2dec('4000')+86, 0, 2);
PathA.RfStatus_RFFB_AGC= RfStatusPathA(2);
PathA.RfStatus_RFIN_AGC= RfStatusPathA(4)*256+RfStatusPathA(5);
% Path A PMU from Scratch
[errFlag, PMU_pathA] = d.msg.ReadXdata(hex2dec('4000')+196, 0, 14);
```

```

PathA.PMU_RFFB =
round(30.1*Convert16B_signed_SC2200(double(PMU_pathA(1))*256+double(PM
U_pathA(2)))/1024)/10;
PathA.PMU_RFIN =
round(30.1*Convert16B_signed_SC2200(double(PMU_pathA(7))*256+double(PM
U_pathA(8)))/1024)/10;
PathA.PMU_PA_Gain =
round(30.1*Convert16B_signed_SC2200(double(PMU_pathA(13))*256+double(P
MU_pathA(14)))/1024)/10;
% Path A Ic Temperature from Scratch
[errFlag, IcTemp_pathA] = d.msg.ReadXdata(hex2dec('4000')+272, 0, 2);
Ic_tempA = IcTemp_pathA(1)*256+IcTemp_pathA(2);
PathA.IcTemp=round(10*Convert16B_signed_SC2200(Ic_tempA)/4)/10;
% Path A PathDevice Firmware Configuration Structure from PRAM
[errorFlag, FwConfigPathA] = d.msg.ReadPram(11+hex2dec('FC14'),4)
if (FwConfigPathA(1)==0)
    PathA.FwConfig_AdaptationState='Running';
else
    PathA.FwConfig_AdaptationState='Frozen';
end
if (FwConfigPathA(4)==1)
    PathA.FwConfig_CorrectionEnable='Disable';
else
    PathA.FwConfig_CorrectionEnable='FW Control';
End
[errorFlag, FwConfigPathA] = d.msg.ReadPram(hex2dec('FC26'),1)
PathA.FwConfig_LinearizerGain = FwConfigPathA(1);
%=====
% Path B Status
%=====
% Path B FwStatusPathB Structure from Scratch
[errFlag, FwStatusPathB] = d.msg.ReadXdata(hex2dec('4000')+72, 0, 14)
stateB= FwStatusPathB(1);
if (stateB == STATUS_VCO_CAL)
    PathB.FwStatus_State='VCO_CAL';
elseif (stateB== STATUS_PDET_AGC)
    PathB.FwStatus_State='PDET_AGC';
elseif (stateB == STATUS_PMU)
    PathB.FwStatus_State='PMU';
elseif (stateB== STATUS_TRACK)
    PathB.FwStatus_State='TRACK';
elseif (stateB== STATUS_FROZEN)
    PathB.FwStatus_State='FROZEN';
elseif (stateB== STATUS_FREQ_SCAN)
    PathB.FwStatus_State='FREQ_SCAN';
elseif (stateB == STATUS_SHUTDOWN)
    PathB.FwStatus_State='SHUTDOWN';
else
    PathB.FwStatus_State='No Valid State';
end
PathB.FwStatus_CenterFrequency=
(double(FwStatusPathB(4))*256+double(FwStatusPathB(5)))/2;

```

```

PathB.FwStatus_SignalBW = FwStatusPathB(6)/2;
PathB.FwStatus_CostFunction =
Convert16B_signed_SC2200(double(FwStatusPathB(8))*256+double(FwStatusP
athB(9)));
% Path BRfStatus Structure from Scratch
[errFlag, RfStatusPathB] = d.msg.ReadXdata(hex2dec('4000')+104, 0, 2);
PathB.RfStatus_RFFB_AGC= RfStatusPathB(2);
PathB.RfStatus_RFIN_AGC= RfStatusPathB(4)*256+RfStatusPathB(5);
% Path B PMU from Scratch
[errFlag, PMU_pathB] = d.msg.ReadXdata(hex2dec('4000')+182, 0, 14);
PathB.PMU_RFFB =
round(30.1*Convert16B_signed_SC2200(double(PMU_pathB(1))*256+double(PM
U_pathB(2)))/1024)/10;
PathB.PMU_RFIN =
round(30.1*Convert16B_signed_SC2200(double(PMU_pathB(7))*256+double(PM
U_pathB(8)))/1024)/10;
PathB.PMU_PA_GAIN =
round(30.1*Convert16B_signed_SC2200(double(PMU_pathB(13))*256+double(P
MU_pathB(14)))/1024)/10;
% Path B IcTemp from Scratch
[errFlag, IcTemp_pathB] = d.msg.ReadXdata(hex2dec('4000')+374, 0, 2);
Ic_tempB = IcTemp_pathB(1)*256+IcTemp_pathB(2);
PathB.IcTemp=round(10*Convert16B_signed_SC2200(Ic_tempB)/4)/10;
% Path B PathDevice Firmware Configuration Structure from PRAM
[errorFlag, FwConfigPathB] = d.msg.ReadPram(11+hex2dec('FC00'),4)
if (FwConfigPathB(1)==0)
    PathB.FwConfig_AdaptationState='Running';
else
    PathB.FwConfig_AdaptationState='Frozen';
end
if (FwConfigPathB(4)==1)
    PathB.FwConfig_CorrectionEnable='Disable';
else
    PathB.FwConfig_CorrectionEnable='FW Control';
end
[errorFlag, FwConfigPathB] = d.msg.ReadPram(hex2dec('FC12'),1)
PathB.FwConfig_LinearizerGain = FwConfigPathB(1);

```

7.7. SC2200_Clear_Calibration

Please refer to section 6 for the 16-byte host command for clear Calibration.

```

function [errorFlag] = SC2200_Clear_Calibration( d, Path)
% d: SC2200 handler. Path: Path A=0 Path B = 1
if(nargin < 2)
    Path = 0;
end
errorFlag = d.msg.ClearCalibrationData(Path, 0);

```

7.8. SC2200_Set_Calibration

Please refer to section 6.2 for the 16-byte host command for Set Calibration.

```
function [errorFlag] = SC2200_Set_Calibration( d, Path)
% d: SC2200 handler. Path: Path A=0 Path B = 1
if(nargin < 2)
    Path = 0;
end
errorFlag = d.msg.SetCalibrationData(Path, 0);
end
```

7.9. Clear InfoStack

```
function [errFlag] = SC2200_Clear_InfoStack(d)
%Write 1 to Global Scratch address 0x330
errFlag = d.msg.WriteXdata(hex2dec('4330'),0,1);
```

7.10. Convert16B_Signed SC2200 (PRAM, Scratch and EEPROM)

```
function [Signed_16Bits_value]= Convert16B_signed_SC2200(value)
%Scratch is big Endian
if (value>hex2dec('7FFF')) % Negative value
    Signed_16Bits_value=double(value)-65536;
else % Positive value
    Signed_16Bits_value=double(value);
end
```

©2016 by Maxim Integrated Products, Inc. All rights reserved. Information in this publication concerning the devices, applications, or technology described is intended to suggest possible uses and may be superseded. MAXIM INTEGRATED PRODUCTS, INC. DOES NOT ASSUME LIABILITY FOR OR PROVIDE A REPRESENTATION OF ACCURACY OF THE INFORMATION, DEVICES, OR TECHNOLOGY DESCRIBED IN THIS DOCUMENT. MAXIM ALSO DOES NOT ASSUME LIABILITY FOR INTELLECTUAL PROPERTY INFRINGEMENT RELATED IN ANY MANNER TO USE OF INFORMATION, DEVICES, OR TECHNOLOGY DESCRIBED HEREIN OR OTHERWISE. The information contained within this document has been verified according to the general principles of electrical and mechanical engineering or registered trademarks of Maxim Integrated Products, Inc. All other product or service names are the property of their respective owners.