

NSR20F40NXT5G

Schottky Barrier Diode

These Schottky barrier diodes are optimized for low forward voltage drop and low leakage current and are offered in a Chip Scale Package (CSP) to reduce board space. The low thermal resistance enables designers to meet the challenging task of achieving higher efficiency and meeting reduced space requirements.

Features

- Very Low Forward Voltage Drop – 550 mV @ 2.0 A
- Low Reverse Current – 15 μ A @ 10 V VR
- 2.0 A of Continuous Forward Current
- Power Dissipation of 665 mW with Minimum Trace
- ESD Rating – Human Body Model: Class 3B
– Machine Model: Class C
- Very High Switching Speed
- These Devices are Pb-Free, Halogen Free/BFR Free and are RoHS Compliant

Typical Applications

- LCD and Keypad Backlighting
- Camera Photo Flash
- Buck and Boost dc-dc Converters
- Reverse Voltage and Current Protection
- Clamping & Protection

Markets

- Mobile Handsets
- MP3 Players
- Digital Camera and Camcorders
- Notebook PCs & PDAs
- GPS

MAXIMUM RATINGS

Rating	Symbol	Value	Unit
Reverse Voltage	V_R	40	V
Forward Current (DC)	I_F	2.0	A
Forward Surge Current (60 Hz @ 1 cycle)	I_{FSM}	28	A
Repetitive Peak Forward Current (Pulse Wave = 1 sec, Duty Cycle = 66%)	I_{FRM}	4.0	A
ESD Rating:			
Human Body Model	ESD	> 8	kV
Machine Model		> 400	V

Stresses exceeding Maximum Ratings may damage the device. Maximum Ratings are stress ratings only. Functional operation above the Recommended Operating Conditions is not implied. Extended exposure to stresses above the Recommended Operating Conditions may affect device reliability.



ON Semiconductor[®]

<http://onsemi.com>

40 V SCHOTTKY BARRIER DIODE

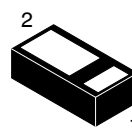
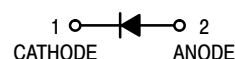

**DSN2
(0603)
CASE 152AB**

MARKING DIAGRAM

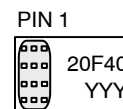

20F40 = Specific Device Code
YYY = Year Code

ORDERING INFORMATION

Device	Package	Shipping†
NSR20F40NXT5G	DSN2 (Pb-Free)	5000 / Tape & Reel

†For information on tape and reel specifications, including part orientation and tape sizes, please refer to our Tape and Reel Packaging Specifications Brochure, BRD8011/D.

NSR20F40NXT5G

THERMAL CHARACTERISTICS

Characteristic	Symbol	Min	Typ	Max	Unit
Thermal Resistance Junction-to-Ambient (Note 1) Total Power Dissipation @ $T_A = 25^\circ\text{C}$	$R_{\theta JA}$ P_D			213 586	$^\circ\text{C}/\text{W}$ mW
Thermal Resistance Junction-to-Ambient (Note 2) Total Power Dissipation @ $T_A = 25^\circ\text{C}$	$R_{\theta JA}$ P_D			80 1.56	$^\circ\text{C}/\text{W}$ W
Storage Temperature Range	T_{stg}			-40 to +125	$^\circ\text{C}$
Junction Temperature	T_J			+150	$^\circ\text{C}$

1. Mounted onto a 4 in square FR-4 board 50 mm sq. 1 oz. Cu 0.06" thick single sided. Operating to steady state.
2. Mounted onto a 4 in square FR-4 board 1 in sq. 1 oz. Cu 0.06" thick single sided. Operating to steady state.

ELECTRICAL CHARACTERISTICS ($T_A = 25^\circ\text{C}$ unless otherwise noted)

Characteristic	Symbol	Min	Typ	Max	Unit
Reverse Leakage ($V_R = 10\text{ V}$) ($V_R = 40\text{ V}$)	I_R			15 150	μA
Forward Voltage ($I_F = 1.0\text{ A}$) ($I_F = 2.0\text{ A}$)	V_F			0.47 0.55	V

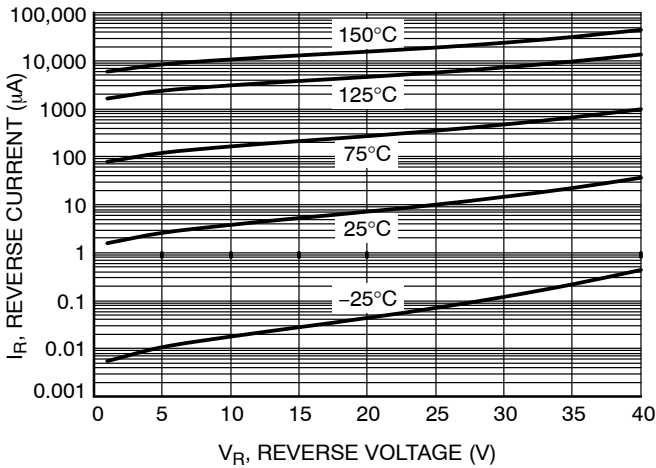

Figure 1. Reverse Current vs. Reverse Voltage

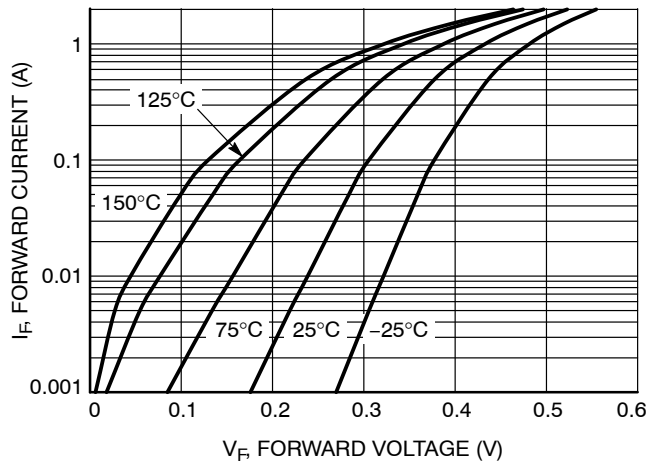

Figure 2. Forward Current vs. Forward Voltage

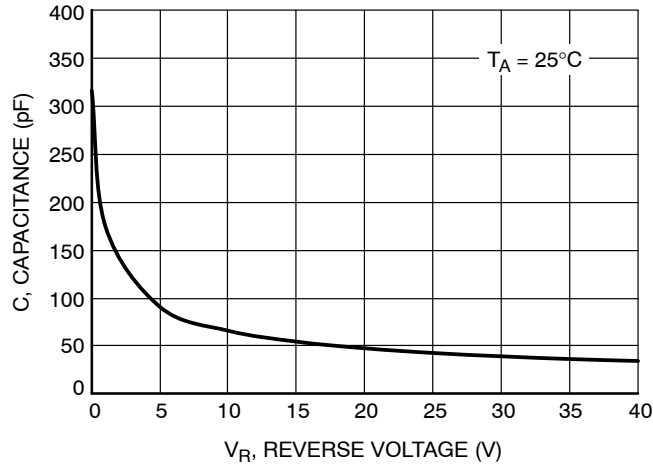

Figure 3. Capacitance

MECHANICAL CASE OUTLINE

PACKAGE DIMENSIONS

ON Semiconductor®



SCALE 8:1

DSN2, 1.6x0.8, 0.9P, (0603)
CASE 152AB
ISSUE C

DATE 30 APR 2017

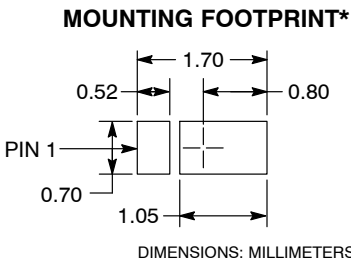
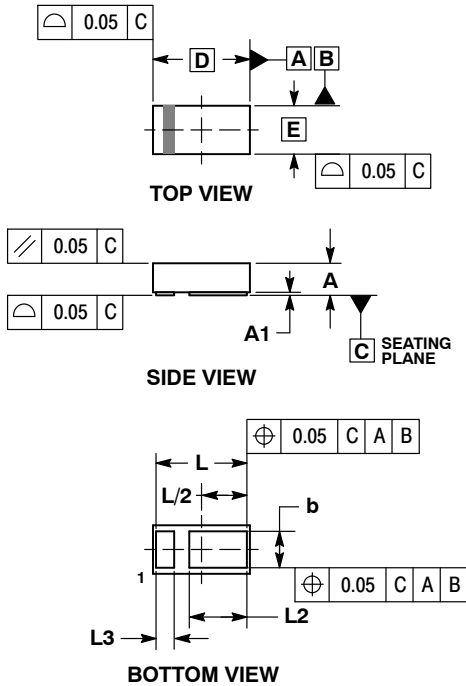

See Application Note AND8464/D for more mounting details

*For additional information on our Pb-Free strategy and soldering details, please download the ON Semiconductor Soldering and Mounting Techniques Reference Manual, SOLDERRM/D.

NOTES:

1. DIMENSIONING AND TOLERANCING PER ASME Y14.5M, 1994.
2. CONTROLLING DIMENSION: MILLIMETERS.

MILLIMETERS		
DIM	MIN	MAX
A	0.25	0.31
A1	---	0.05
b	0.55	0.65
D	1.60 BSC	
E	0.80 BSC	
L	1.45	1.55
L2	0.90	1.00
L3	0.25	0.35

GENERIC MARKING DIAGRAM1*
PIN 1

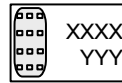

XXXX = Specific Device Code
YYY = Year Code

GENERIC MARKING DIAGRAM2*
PIN 1



XX = Specific Device Code
M = Date Code

*This information is generic. Please refer to device data sheet for actual part marking. Pb-Free indicator, "G", may or not be present. Some products may not follow the Generic Marking.

CATHODE BAND MONTH CODING

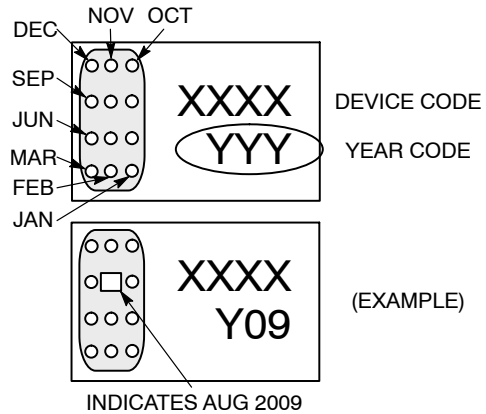

DOCUMENT NUMBER:	98AON40452E	Electronic versions are uncontrolled except when accessed directly from the Document Repository. Printed versions are uncontrolled except when stamped "CONTROLLED COPY" in red.
DESCRIPTION:	DSN2, 1.6X0.8, 0.9P, (0603)	PAGE 1 OF 1

ON Semiconductor and are trademarks of Semiconductor Components Industries, LLC dba ON Semiconductor or its subsidiaries in the United States and/or other countries. ON Semiconductor reserves the right to make changes without further notice to any products herein. ON Semiconductor makes no warranty, representation or guarantee regarding the suitability of its products for any particular purpose, nor does ON Semiconductor assume any liability arising out of the application or use of any product or circuit, and specifically disclaims any and all liability, including without limitation special, consequential or incidental damages. ON Semiconductor does not convey any license under its patent rights nor the rights of others.

onsemi, **Onsemi**, and other names, marks, and brands are registered and/or common law trademarks of Semiconductor Components Industries, LLC dba "**onsemi**" or its affiliates and/or subsidiaries in the United States and/or other countries. **onsemi** owns the rights to a number of patents, trademarks, copyrights, trade secrets, and other intellectual property. A listing of **onsemi**'s product/patent coverage may be accessed at www.onsemi.com/site/pdf/Patent-Marking.pdf. **onsemi** reserves the right to make changes at any time to any products or information herein, without notice. The information herein is provided "as-is" and **onsemi** makes no warranty, representation or guarantee regarding the accuracy of the information, product features, availability, functionality, or suitability of its products for any particular purpose, nor does **onsemi** assume any liability arising out of the application or use of any product or circuit, and specifically disclaims any and all liability, including without limitation special, consequential or incidental damages. Buyer is responsible for its products and applications using **onsemi** products, including compliance with all laws, regulations and safety requirements or standards, regardless of any support or applications information provided by **onsemi**. "Typical" parameters which may be provided in **onsemi** data sheets and/or specifications can and do vary in different applications and actual performance may vary over time. All operating parameters, including "Typicals" must be validated for each customer application by customer's technical experts. **onsemi** does not convey any license under any of its intellectual property rights nor the rights of others. **onsemi** products are not designed, intended, or authorized for use as a critical component in life support systems or any FDA Class 3 medical devices or medical devices with a same or similar classification in a foreign jurisdiction or any devices intended for implantation in the human body. Should Buyer purchase or use **onsemi** products for any such unintended or unauthorized application, Buyer shall indemnify and hold **onsemi** and its officers, employees, subsidiaries, affiliates, and distributors harmless against all claims, costs, damages, and expenses, and reasonable attorney fees arising out of, directly or indirectly, any claim of personal injury or death associated with such unintended or unauthorized use, even if such claim alleges that **onsemi** was negligent regarding the design or manufacture of the part. **onsemi** is an Equal Opportunity/Affirmative Action Employer. This literature is subject to all applicable copyright laws and is not for resale in any manner.

ADDITIONAL INFORMATION

TECHNICAL PUBLICATIONS:

Technical Library: www.onsemi.com/design/resources/technical-documentation
onsemi Website: www.onsemi.com

ONLINE SUPPORT: www.onsemi.com/support

For additional information, please contact your local Sales Representative at www.onsemi.com/support/sales